

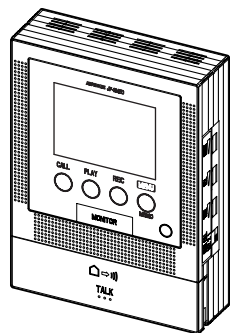

JF-2MED, JF-2HD

**HANDS-FREE COLOR VIDEO INTERCOM
INTERPHONE VIDEO COULEUR MAINS LIBRES
HANDENVRIJE KLEURENVIDEOFONIE**



JF-2MED
Master monitor station
Moniteur maître
Monitor-hoofdpost

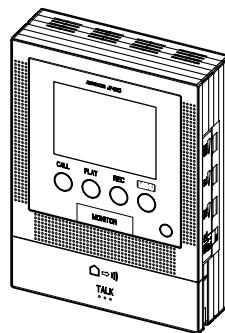

JF-2HD
Sub monitor station
Moniteur secondaire
Monitor-bijpost

**INSTALLATION & OPERATION MANUAL
MANUEL D'INSTALLATION ET D'UTILISATION
INSTALLATIE- EN BEDIENINGSHANDLEIDING**

PRECAUTIONS

- ⊘ General Prohibitions
 ⊘ Prohibition to Dismantle the Unit
 ⊘ Prohibition on Subjecting the Unit to Water
 ! General Precautions

⚠ WARNING

(Negligence could result in death or serious injury.)

- ⊘ 1. High voltage is present internally. Do not open the case. Electric shock could result.
- ⊘ 2. Do not dismantle or alter the unit. Fire or electric shock could result.
- ⊘ 3. Do not connect any non-specified power source to the +, - terminals, and do not install two power supplies in parallel to a single input. Fire or damage to the unit could result.
- ⊘ 4. Keep the unit away from water or any other liquid. Fire or electric shock could result.
- ⊘ 5. Do not put any metal or flammable material into the unit through the openings. Fire or electric shock could result.
- ⊘ 6. Voltage is present internally. Do not touch any parts other than the mounting, wiring and connection points. Electric shock could result.
- ⊘ 7. Do not use power supply with a voltage other than specified. Fire or electric shock could result.
- ⊘ 8. Do not connect any terminal on the unit to AC power lines. Fire or electric shock could result.

⚠ CAUTION

(Negligence could result in injury to people or damage to property.)

- ⊘ 1. Do not install or make any wire terminations while power supply is plugged in. It can cause electrical shock or damage to the unit.
- ! 2. Before turning on power, make sure wires are not crossed or shorted. If not, fire or electric shock could result.
- ! 3. When mounting the unit on wall, install the unit in a convenient location, but not where it could be jarred or bumped. Injury could result.
- ! 4. For power supply, use Aiphone power supply model specified with system. If non-specified product is used, fire or malfunction could result.
- ⊘ 5. Do not install the unit in any of the following locations. Fire, electric shock, or unit trouble could result.
 - * Places under direct sunlight, or near heating equipment that varies in temperature.
 - * Places subject to dust, oil, chemicals, etc.
 - * Places subject to moisture and humidity extremes, such as bathroom, cellar, greenhouse, etc.
 - * Places where the temperature is quite low, such as inside a refrigerated area or in front of air-conditioner.
 - * Places subject to steam or smoke (near heating or cooking surfaces).
 - * Where noise generating devices such as dimmer switches or inverter electrical appliances are close by.
- ⊘ 6. Do not put anything on or cover the unit with cloth, etc. Fire or unit trouble could result.
- ⊘ 7. Do not press on the LCD or subject it to a high impact. The LCD glass could be punctured and result in an injury.
- ⊘ 8. If LCD is punctured, do not allow contact with the liquid crystal inside. Inflammation could result.
 - * If necessary, gargle your mouth and clean your eyes or skin with clear water for at least 15 minutes, and consult your doctor.

GENERAL PRECAUTIONS

1. Keep the unit more than 1 m away from radio or TV set.
2. This unit is for indoor use only. Do not use outdoors.
3. In areas where broadcasting station antennas are close by, the intercom system may be affected by radio frequency interference.
4. As to other manufacturer's devices (such as sensor, detectors, door releases) used with this system, comply with the Specifications and Warranty conditions that the manufacturers or vendors present.
5. Keep the intercom wires more than 30 cm (12") away from AC 100~240 V lines. Noise and malfunction could result.
6. If the unit is down or does not operate properly, unplug the power supply or turn off the JF-2MED and JF-2HD Power switches.
7. The unit is for wall-mount use only. For desktop applications, use desk stand.
8. When wall-mounted, the unit may become dusty. Clean with a soft cloth.
9. The unit case may become a warm with use, but this is not a unit malfunction.
10. If a cellular phone is used close by, the unit may malfunction.
11. It must be noted in advance that the LCD panel, though manufactured with very high precision techniques, inevitably will have a very small portion of the picture elements steadily lit or not lit at all, which is not considered a unit malfunction.
12. Refrain from using the color monitor station in sunlit areas.
13. At night, due to reduced lighting on the object, the monitor sees more noise and the face becomes more difficult to see, but this is not malfunction.
14. Talk within 50 cm (20") or less from the unit. If you stand too far away, it may be difficult for the other person to hear the communication.
15. If there are loud noises around the unit (such as music playing or children crying), the sound may break up and be difficult to hear.
16. During communication, if you speak before the other person has finished talking, your voice may not be heard. Communication will proceed smoothly if you wait until the other person has finished before speaking.
17. At a gate or porch illuminated by fluorescent lamp, the picture may vary, but this is not a malfunction.
18. When outside temperature lowers sharply after rainfall, etc., the inside of the camera may fog up slightly, causing a blurry picture, but this is not a malfunction. Normal operation will be restored when moisture evaporates.
19. Due to the environmental sound around the unit, it may hinder smooth communication, but this is not a malfunction.

English

Français

Nederlands

1 PACKAGE CONTENTS

JF-2MED or JF-2HD

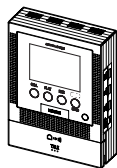

Mounting screws x 2



Wood mounting screws x 2



Option connector



Release connector (JF-2MED only)



Installation & Operation manual

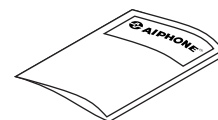

2 INSTALLATION

2-1 Mounting locations

1 Install the master monitor station and sub monitor station in places where the screens are not exposed to direct sunlight.

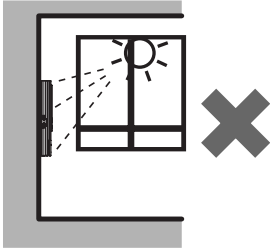

2 The master monitor station and sub monitor station have switches on both sides. Allow at least 5 cm (2") of open space on either side.

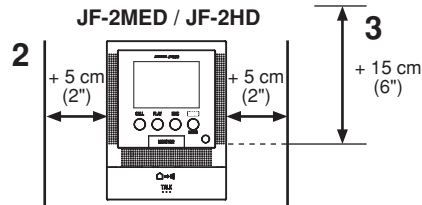

3 Allow 15 cm (6") or more of vertical open space from the center of the mounting bracket in order to mount the master monitor station and sub monitor station.

2-2 Wiring method, Wiring distance

Wire the units from station-to-station (daisy-chained).

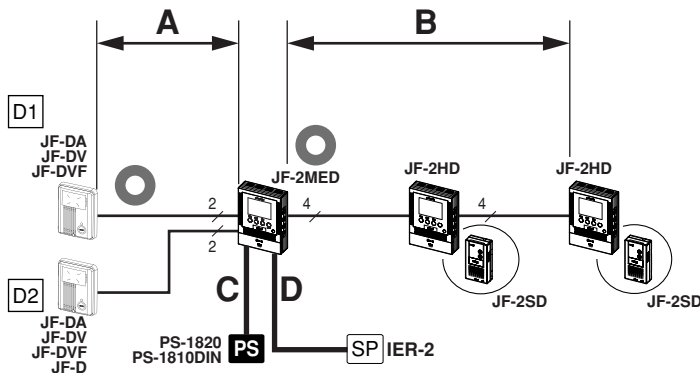

	Ø 0,65 mm	22AWG	Ø 1,0 mm	18AWG
A	50 m	165'	100 m	330'
B	50 m	165'	100 m	330'
C	5 m	16'	10 m	33'
D	75 m	245'	150 m	490'

Incorrect method

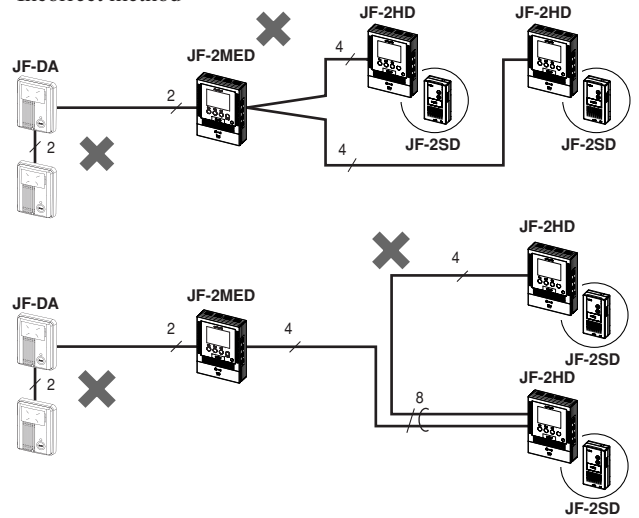

2-3 Cable

1 Parallel or jacketed 2-conductor, mid-capacitance non-shielded cable is recommended. PVC jacket with PE (polyethylene) insulated conductors is recommended.

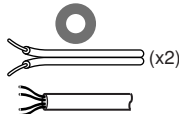

2 Never use individual conductors, twisted pair cable or coaxial cable.

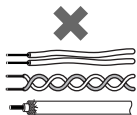

3 When using a cable with unused conductors, terminate both ends of the unused pair(s) with a 120 Ω resistor.

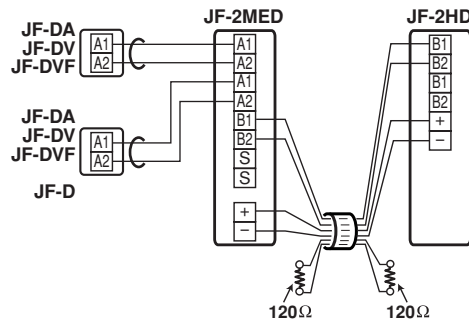

3 WIRING

Insert wires securely into each terminal as shown.

English

Français

Nederlands

DOOR 1 Video door station

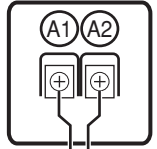
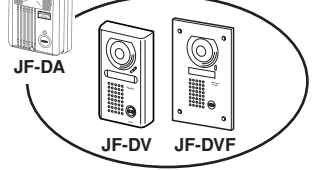

DOOR 2

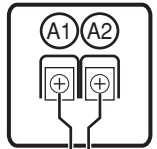
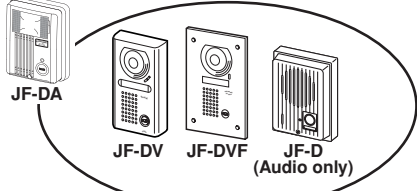

Optional call extension speaker IER-2



JF-2MED Master monitor station

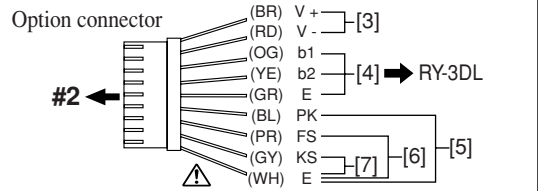
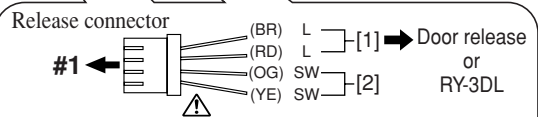
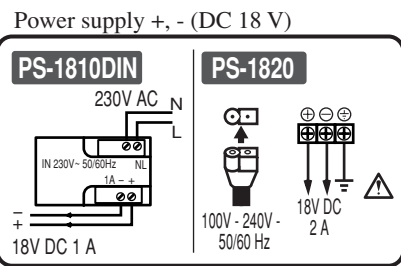
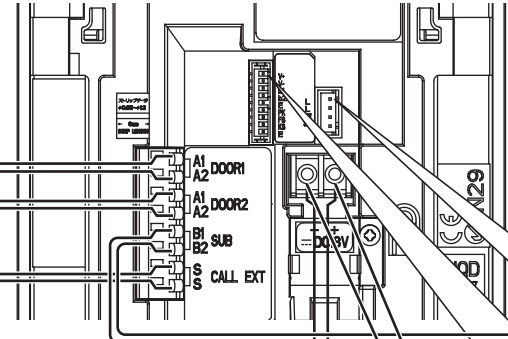

To prevent shorts, be sure to cut unused lead wires at the bottom and insulate the ends.

Control external devices connected with release connector and option connector.

[1] Door release output **Setting is required.** (Refer to section 7-8) (AC/DC 24 V, 0.5 A N/O dry closure contact) Connect the brown and red wires from the release connector to the door release (or to the RY-3DL as shown in the wiring diagram).

[2] Options output (AC/DC 24 V, 1.6 A N/O dry closure contact)

[3] Video signal output (NTSC, 1 Vp-p/75 Ω) Wiring distance: 3 m

[4] Door release-linked entrance output

[5] Press-to-talk setting input If the blue and white wires are shorted, press-to-talk will not be operable.

[6] Foot switch input Connect a commercially-available foot switch to the purple and white wires (N/O dry closure contact).

[7] External sensor input **Setting is required.** (Refer to section 7-9)

Input method	N/O dry closure contact External sensor input (start signal only detection method)
Detection confirmation time	100 mS or more
Contact resistance	During dry closure: Less than 700 Ω
Terminal short current	Less than 10 mA
Voltage between terminals	Less than DC 20 V (when open between terminals)

Door release

Door release EL-9S (AC 12 V, 0.35 A) or equivalent, requires a separate AC transformer. Run separate cables for audio/video and door release.
Door release contact: AC/DC 24 V, 0.5 A (N/O dry closure contact L, L).

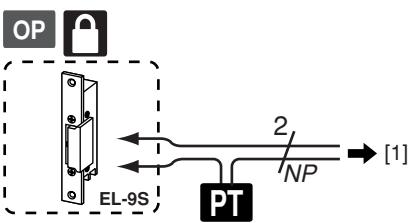

Optional selective door release adaptor RY-3DL Use RY-3DL when connecting door release to 2 locations.

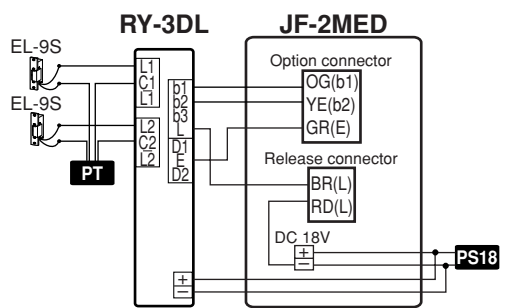

PT AC Transformer

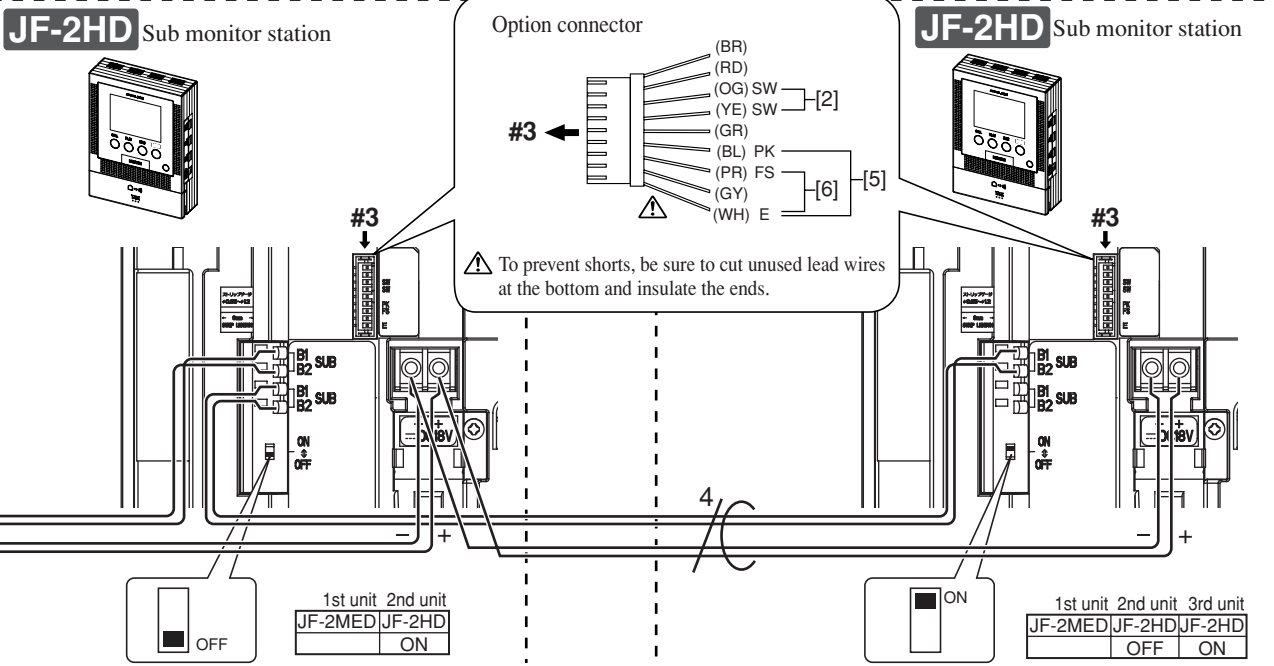

NP: Non-polarized
P: Polarized

BR: Brown
 RD: Red
 OG: Orange
 YE: Yellow
 GR: Green
 BL: Blue
 PR: Purple
 GY: Gray
 WH: White

• Terminal setting (2nd unit)
 Setting changes are only required when a 3rd unit is connected. Put the switch in the ON position, and terminate the furthest sub station. If the terminal setting is incorrect, the monitor station and sub station will make a warning sound when they are operated. Further, the unit may not operate correctly or the video image may distort.

ON ON side when no 3rd unit is connected (leave in the factory settings)
 OFF OFF side when a 3rd unit is connected

⚠ After changing the setting, be sure to turn the power of the monitor station on again.

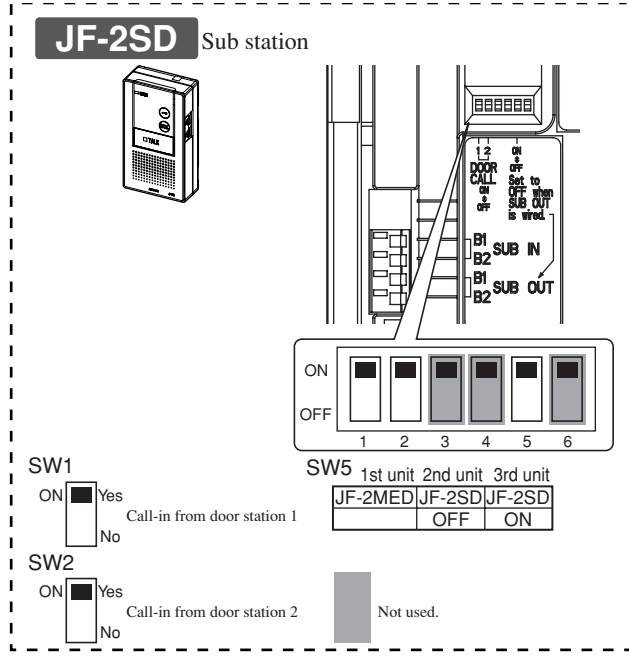
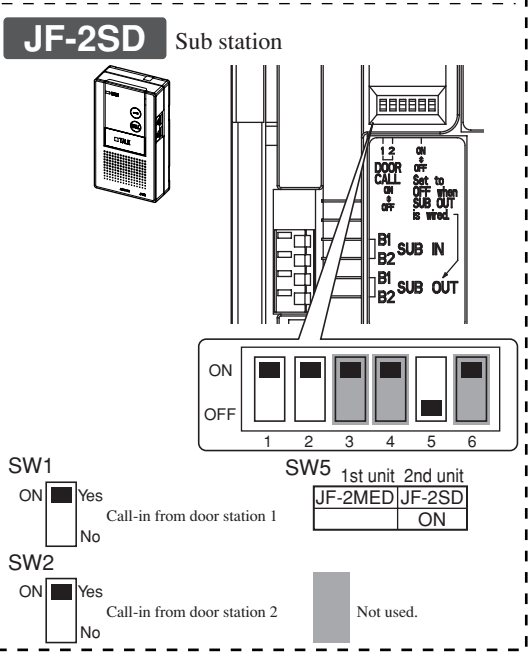

Optional long distance adaptor JBW-BA

Use JBW-BA when the wiring distance between the video door station and JF-2MED is within the distance range shown in the table.
 ⚠ 1. Use PE (polyethylene) insulated cable. Do not use PVC.

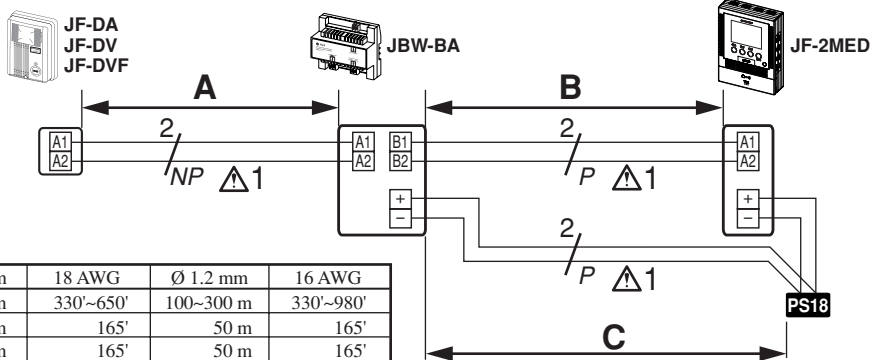

	Ø 1.0 mm	18 AWG	Ø 1.2 mm	16 AWG
A	100~200 m	330'~650'	100~300 m	330'~980'
B (max.)	50 m	165'	50 m	165'
C (max.)	50 m	165'	50 m	165'

4 MOUNTING

Back wiring

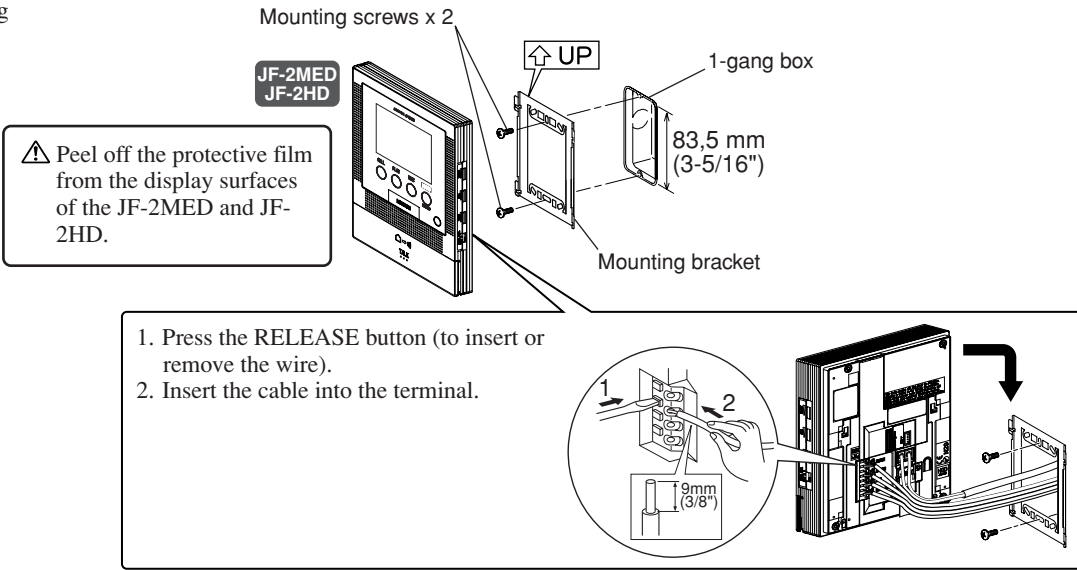

Surface wiring

*When a 1-gang box is not mounted, the cable can be surface-run to the top or bottom of the unit. Cut the cable inlet to allow passage of the wiring into the unit.

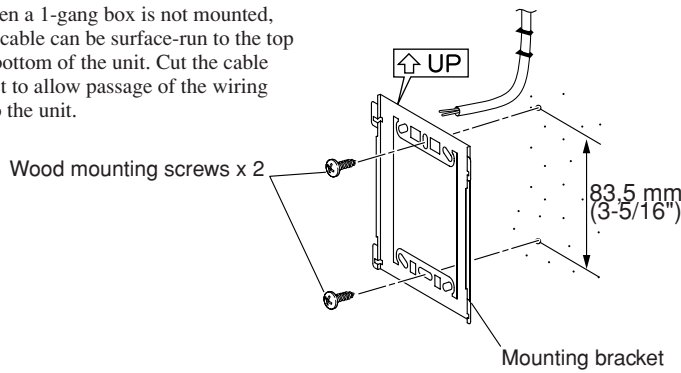

PS-1820

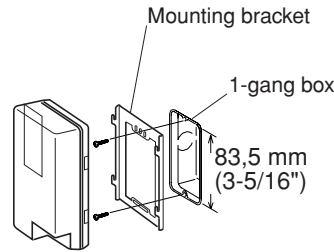

PS-1810DIN

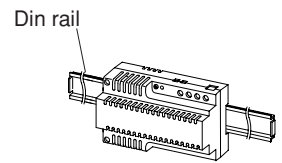

5 NAMES

JF-2MED

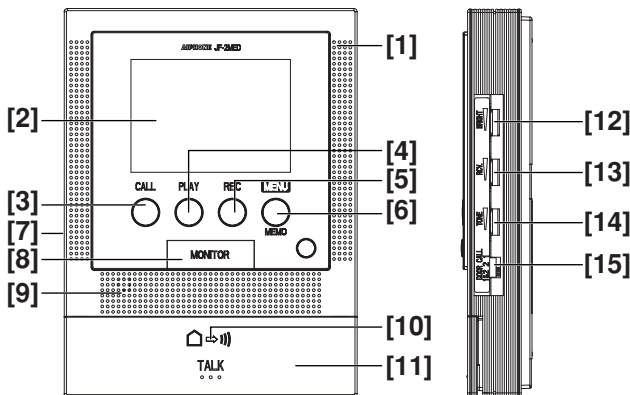

JF-2HD

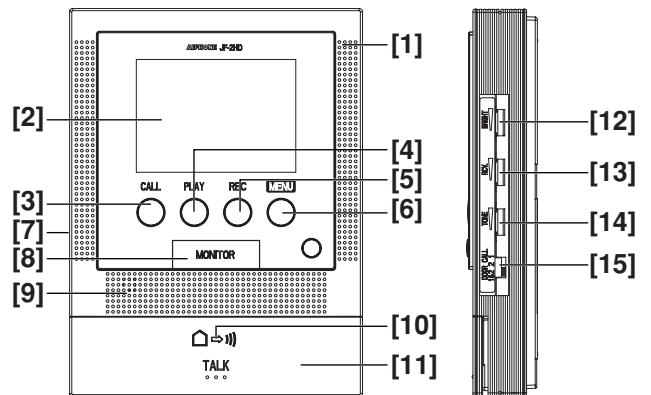

- [1] Microphone
- [2] Color LCD video monitor (3-1/2" color)
- [3] CALL button, door call-in LED (red)
- [4] PLAY button, play LED (red)
- [5] REC button, record LED (red)
- [6] MENU/MEMO button, memo LED (red) (JF-2MED)
MENU button (JF-2HD)
- [7] POWER switch
- [8] MONITOR button

- [9] Speaker
- [10] Transmit LED (red)
- [11] TALK button
- [12] Screen brightness control
- [13] Receive volume control (high to off)
- [14] Chime tone, alert sound volume (high to off)
- [15] Call-in setting switch
"1": Call-in from door station 1 only.
"2": Call-in from door station 2 only.
"1&2": Call-in from both door station 1 and door station 2.

6 OPERATING METHOD

To operate this unit, check the symbol and then press the appropriate operation button. This is not a touch-panel operation.

Operation guidance display
The guidance differs according to the screen.

Symbol
The symbols differ according to the screen.

Operation buttons
Press to select a symbol that is displayed on the screen.
* The name of the operation button may differ from the name of the symbol.

To operate a symbol, press the operation button that is below the symbol.
Example: To activate the door release, press CALL button that is below the symbol.

Main symbols and function descriptions

Symbol	Function description
	To activate Door release.
	To play Message 1 for entrance.
	To play Message 2 for entrance.
	To manually record. To record Voice memo or Message for entrance.
	To return to the screen of the previous operation.
	To display the previous (more recent date) image.
	To play Recorded image or Voice memo.
	To display the next (older date) image.
	To save or erase an image.
	To erase a Voice memo. To erase a Recorded image.
	To move the cursor up.
	To move the cursor down.
	To fast forward the play screen.
	To pause the play screen.
	To advance the play screen frame by frame.
	To reverse the play screen frame by frame.

7 SETTING UP

7-1 Setting screens and display methods JF-2MED

1 In the standby mode, press the MENU/MEMO button until the setting screen is displayed (approx. 3 seconds).

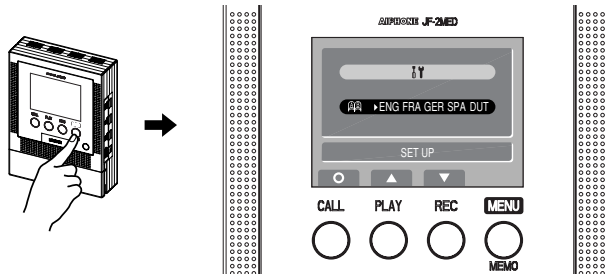

2 Press PLAY button or REC button to select "SET UP", and press CALL button.

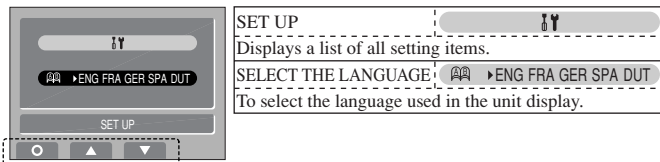

3 Press PLAY button or REC button to select the item you want to set or check, and set with CALL button.

SET THE DATE/TIME	☉± 2006 01 JAN 00:00
To set the year, date, and time.	
SET THE BACKGROUND COLOR	▶ ◻ ◻ ◻ ◻ ◻ ◻ ◻ ◻ ◻ ◻
To set the screen background color.	
SELECT CALL TONE (DOOR1)	🎵 1 2 3 4
To set the chime tone for door station 1.	
SELECT CALL TONE (DOOR2)	🎵 1 2 3 4
To set the chime tone for door station 2.	
RECORD MESSAGE	🎤
To record a greeting message.	
SET DOOR2	🔌 📺 🗑️ ✕
To set the connection for door station 2.	
SET DOOR RELEASE	🔑 ▶ ○ ✕
To set whether the door release is on or off.	
SET EXTERNAL SENSOR INPUT	🔌 ▶30 ⏸ 📶
To set the external sensor input.	
RESTORE DEFAULT SETTING	🔄
To initialize the settings.	

4 Press TALK button to return to the standby mode.

- ⚠ 1. When using the unit for the first time, set the time first. If the unit is used without setting the time, the play LED (red) and record LED (red) light at the same time as a notification.
- ⚠ 2. When power is not supplied to the unit for a long time, the time returns to its initial setting of "2006 01 JAN 00 : 00", and the play LED (red) and record LED (red) light at the same time as a notification. Reset the time.

- ⚠ 3. The installer must perform "SET DOOR2", "SET DOOR RELEASE" and "SET EXTERNAL SENSOR INPUT". Please do not change these settings yourself.

7-2 SELECT THE LANGUAGE JF-2MED

1 After performing step 1 in section 7-1, select "SELECT THE LANGUAGE" and press CALL button.

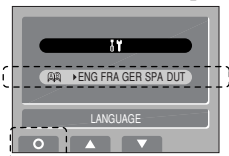

2 In the language selection screen, press the PLAY button or REC button to select the language.

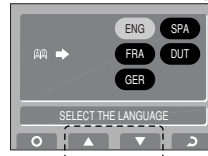

3 Press the CALL button to set.



7-3 SET THE DATE/TIME JF-2MED

1 After performing steps 1 and 2 in section 7-1, select "SET THE DATE/TIME" and press CALL button.

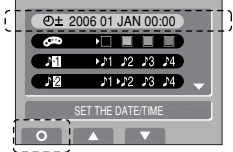

2 In the time setting screen, press PLAY button or REC button to set the "Year".

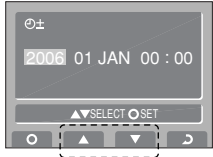

3 Press CALL button to set the "Year" and move the cursor to "Month".

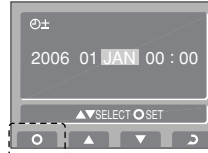

4 Perform the same steps to set the "Month", "Day", "Hour" and "Minute". After setting "Minute", press CALL button to complete the settings.

5 Press TALK button to return to the standby mode.

⚠ 1. If there are no operations for approx. 1 minute during the setup mode, the setting will end automatically. If the settings end while incomplete, start again from the beginning.

⚠ 2. A maximum error of ± 1 minute can occur in the displayed time over a month.

NOTES: Button operations for setting date/time

- PLAY button (press once): The date/time increases by one.
- PLAY button (press and hold for 1 second or more): The date/time increases in succession.
- REC button (press once): The date/time decreases by one.
- REC button (press and hold for 1 second or more): The date/time decreases in succession.
- MENU/MEMO button: Return to the setting screen without saving the setting.
- CALL button: Confirm the setting.

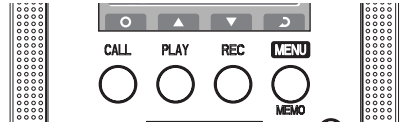

7-4 SET THE BACKGROUND COLOR JF-2MED

The background color for the screen can be selected from 4 alternatives: "Black", "Orange", "Green" and "Blue". When a sub monitor station is connected, the screen background color for the sub monitor station also changes.

1 After performing steps 1 and 2 in section 7-1, select "SET THE BACKGROUND COLOR" and press CALL button.

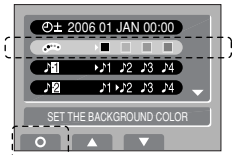

2 In the "SET THE BACKGROUND COLOR" screen, press PLAY button or REC button to select the desired color. The background color changes to the selected color, enabling you to check the color.

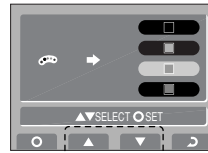

3 Press CALL button to complete the settings and return to the setting screen.



7-5 SELECT CALL TONE JF-2MED

The chime tone for the video door station can be selected from 4 sound types.

1 After performing steps 1 and 2 in section 7-1, select "SELECT CALL TONE (DOOR1)" or "SELECT CALL TONE (DOOR2)" and press CALL button.

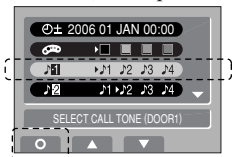

2 In the "SELECT CALL TONE" screen, press PLAY button or REC button to select the desired chime tone. The selected chime tone sounds, enabling you to check the sound.

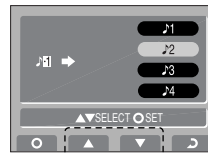

3 Press CALL button to complete the settings and return to the setting screen.



7-6 RECORD MESSAGE JF-2MED

A maximum of 2 messages can be recorded (approx. 10 seconds per message).

1 After performing steps 1 and 2 in section 7-1, select "RECORD MESSAGE" and press CALL button.



2 In the message recording screen, press CALL button or PLAY button to select the record location. If a message has already been recorded, the selected message is played, enabling you to check the contents of the recording.

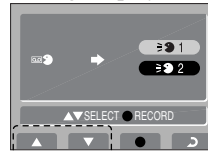

- ⇒ 1 Message 1 for entrance
- ⇒ 2 Message 2 for entrance

3 Press the REC button to record a message. Recording is possible for approx. 10 seconds.



4 After approx. 10 seconds have passed, press CALL button to complete the recording.



7-7 SET DOOR2 JF-2MED

When connecting door station 2, set "Video", "Audio" or "None" (door station 2 not connected).

⚠ These operations must be performed by an installer. Please do not change these settings yourself.

- 1 After performing steps 1 and 2 in section 7-1, select "SET DOOR2" and press CALL button.

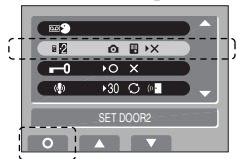

- 2 In the "SET DOOR2" screen, press PLAY button or REC button to select the type of door station that is connected.

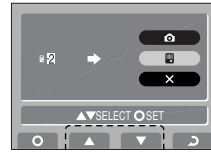

- Video door station
- Audio door station
- Door station 2 not connected

- 3 Press CALL button to complete the settings and return to the setting screen.



7-8 SET DOOR RELEASE JF-2MED

When not connecting the door release, set to "Not use".

⚠ These operations must be performed by an installer. Please do not change these settings yourself.

- 1 After performing steps 1 and 2 in section 7-1, select "SET DOOR RELEASE" and press CALL button.

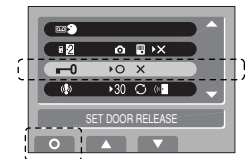

- 2 In the "SET DOOR RELEASE" screen, press the PLAY button or REC button to select the setting. When "Not use" is selected, door release symbol is not displayed on the menu screen. (Refer to section 8-2)

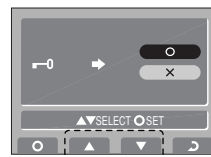

- Use
- Not use

- 3 Press CALL button to complete the settings and return to the setting screen.



7-9 SET EXTERNAL SENSOR INPUT JF-2MED

When optional units operate (for example, when a sensor is activated or a call button is pressed), the master monitor station and sub station will receive a notification sound. Further, when  is set, door station 1 also receives a notification sound.

⚠ These operations must be performed by an installer. Please do not change these settings yourself.

- 1 After performing steps 1 and 2 in section 7-1, select "SET EXTERNAL SENSOR INPUT" and press CALL button.

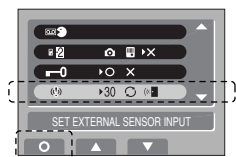

- 2 In the "SET EXTERNAL SENSOR INPUT" screen, press PLAY button or REC button to select the notification sound contents.



- 30 The notification sound stops after 30 seconds.
- Continuous The notification sound operates continuously.
- Outdoor output The notification sound operates continuously, and is also sounded at door station 1.

- 3 Press CALL button to complete the settings and return to the setting screen.



7-10 RESTORE DEFAULT SETTING JF-2MED

All settings can be restored to their condition at the time of purchase.

1. Once the settings are initialized, they cannot be restored to their previous settings.
2. Recorded images, Voice memos, and Messages for the entrance are also all erased.

Settings reset with "RESTORE DEFAULT SETTING"

Setting name	Available settings
Time	2006 01 JAN 00 : 00
Screen background color	Black Orange Green Blue
Door station 1 chime tone	♪1 (Tone 1) ♪2 (Tone 2) ♪3 (Tone 3) ♪4 (Tone 4)
Door station 2 chime tone	♪1 (Tone 1) ♪2 (Tone 2) ♪3 (Tone 3) ♪4 (Tone 4)
Door station 2	<input checked="" type="radio"/> (Video) <input checked="" type="radio"/> (Audio) <input checked="" type="radio"/> (None)
Door release on or off	<input type="radio"/> (Use) <input checked="" type="radio"/> (Not use)
External sensor input	30 (30 seconds) Continuous <input checked="" type="radio"/> (Outdoor output)

* are the initial values.

- 1 After performing steps 1 and 2 in section 7-1, select "RESTORE DEFAULT SETTING" and press CALL button.

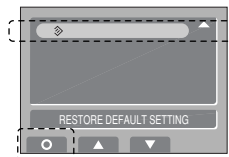

- 2 In the "RESTORE DEFAULT SETTING" screen, press CALL button to initialize. Press PLAY button to return to the setting screen.

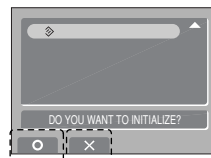

- 3 "INITIALIZING" is displayed. Initializing takes approx. 10 to 20 seconds.

8 OPERATIONS

8-1 Answering a door call (HANDS-FREE mode, PTT mode)

1 Press CALL button.



2 Chime tone sounds, caller is seen on video monitor, and outside sound is heard.

- Audio and video turns off after approx. 45 seconds in not answered.

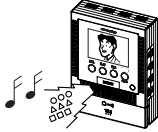

3 Press TALK button momentarily, and after the beep, communicate hands-free. Transmit LED (red) lights when you talk, and goes off as you listen to caller (or hear outside sounds).

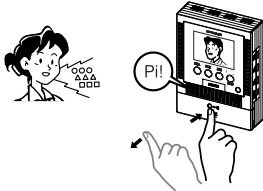

4 Press TALK button once again, and after the beep, communication ends.

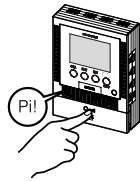

NOTES: Communication (video) ends automatically after approx. 1 minute.

Instant voice call function

2 Even without answering, door area can be seen and heard with video and audio (for approx. 45 seconds). Inside sound is not heard outside.

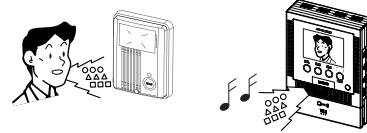

PTT mode

3 During communication, press and hold TALK button for 1 second or more to change to press-to-talk mode. A beep sounds, and after approx. 1 second another beep sounds, PTT mode is entered. If TALK button is pressed briefly (less than 0.5 seconds), communication ends.

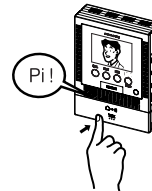

4 To continue speaking using the press-to-talk mode, press TALK button for 1 second or more each time to talk, and release to listen to the caller.

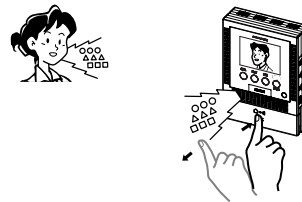

5 Press TALK button again momentarily, and after the beep, communication ends.

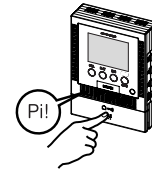

NOTES: If the blue and white wires of the option connector are shorted, PTT mode will not be operable.

8-2 Activating door release

1 During communication, instant voice call or entrance monitoring, press MENU/MEMO button to display the menu screen.

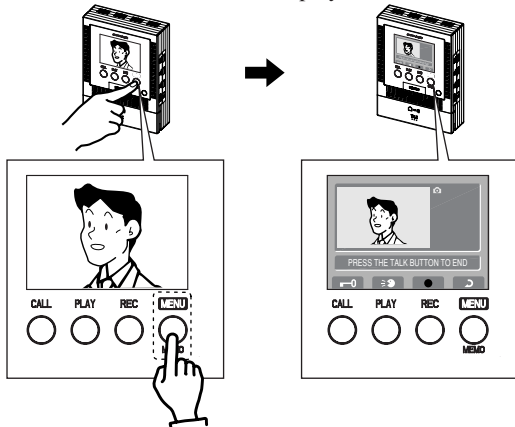

2 Press CALL button.

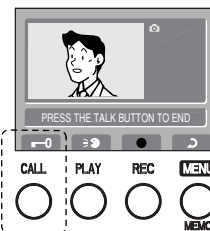

NOTES: When SET DOOR RELEASE setting is set to "Not use", the release symbol is not displayed and the release cannot be performed. (Refer to section 7-8)

3 Open door while the release mechanism is activated. During activation of door release, the release symbol is displayed.



8-3 Message for entrance

1 During communication, instant voice call or entrance monitoring, press MENU/MEMO button to display the menu screen.

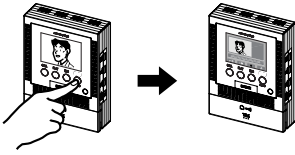

2 Press PLAY button.

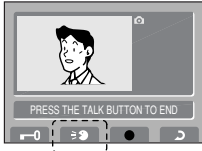

3 Press either CALL button or PLAY button. The selected Message changes to yellow, "SENDING MESSAGE" is displayed, and the selected message is played from door station.

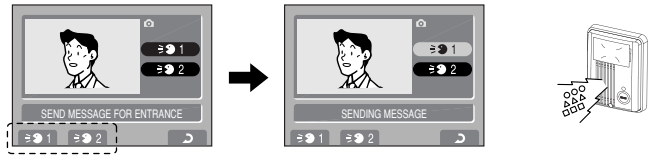

NOTES: Record separate messages in advance for Message 1 and Message 2. (Refer to section 7-6)

8-4 Entrance monitoring

1 Press MONITOR button in the standby mode.

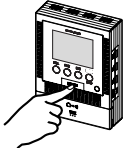

2 The video monitor displays the image from door station 1 and the incoming audio is heard. If you do not press TALK button, the caller will not hear sounds from the inside station.

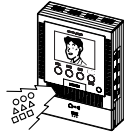

3 Press MONITOR button again to switch to door station 2. Each time MONITOR button is pressed, the unit switches in the sequence "Standby" to "Door station 1 monitor" to "Door station 2 monitor" to "Standby". When "Audio door station" or "Door station 2 not connected" is set in the door station 2 setting, "Door station 2 monitor" is skipped (door station 2 cannot be monitored). (Refer to section 7-7)

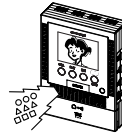

4 Press MONITOR button again to end.

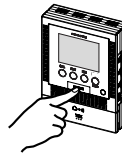

NOTES: 1. To talk to the entrance during monitoring, momentarily press TALK button. Press TALK button again to end communication.
2. The entrance monitoring turns off automatically after approx. 1 minute. To monitor the entrance again, repeat from the beginning.

8-5 Room-to-room communication

1 Press CALL button to talk with the other person.

- CALL button (red) flashes and the "All Call" function is activated to link all the master/sub stations.
- The reply of the other person is not heard.

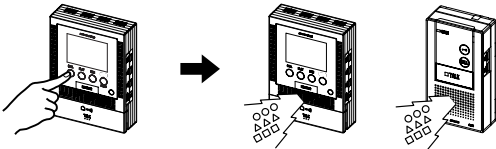

2 If the other person presses TALK button, hands-free communication is possible.

⚠ Do not press TALK button during communication. It will end the communication.

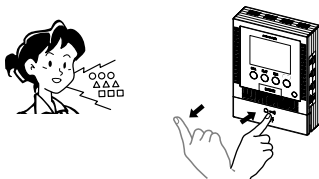

3 Press and release TALK button to end.

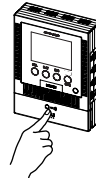

NOTES: 1. Room-to-room communication ends automatically after approx. 10 minutes. To perform room-to-room communication again, repeat from the beginning.
2. If a call is received from the entrance during room-to-room communication, a chime tone sounds from the monitor station and sub station where communication is taking place. Press TALK button to end the room-to-room communication, and press TALK button again to switch to communication with door station from which the call was received.

8-6 Transfer entrance call

- 1 During communication with door station, press CALL button to call the transferring station.
 - CALL button (red) flashes and the communication with door station is put on hold.
 - The "All Call" function is activated to link all the master/sub stations.

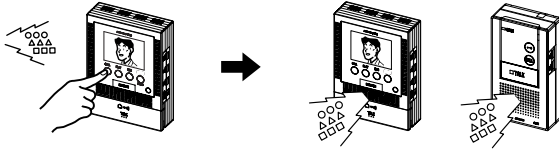

- 2 If TALK button is pressed at the transferred station, the unit enters room-to-room communication. The sender informs the receiver that communication will be transferred, and TALK button is pressed and released at either the transferring station or transferred station to end the room-to-room communication. (The screen continues to display the image of door station.)

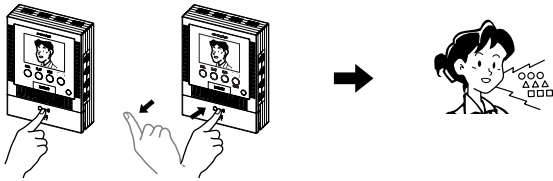

- 3 If TALK button is pressed at the transferred station, communication with door station is performed (the transferring station's screen goes off). Press TALK button to end communication.

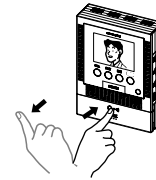

NOTES: 1. If TALK button is pressed at the transferring station before starting communication between the transferred station and door station, the unit enters the condition where the forwarding source communicates with door station. After ending the room-to-room communication in step 2, TALK button must not be pressed at the transferring station for a while (until the transferred station enters communication with door station).

2. Communication (video) with door station ends automatically approx. 1 minute after first starting the communication. Press TALK button within 30 seconds to start it again.

8-7 Automatic recording

If a call is received from video door station, the unit starts recording automatically. The record LED (red) flashes during recording (JF-2MED only).

- The recording starts approx. 2 seconds after CALL button of video door station is pressed. A maximum length of approx. 8 seconds (8 shots) can be recorded with 1 picture and 1 shot for each second.
- A maximum of 50 pictures can be recorded (combined total of automatic recording and manual recording pictures). If 50 pictures are exceeded, pictures are overwritten starting from the picture with the oldest recording date.

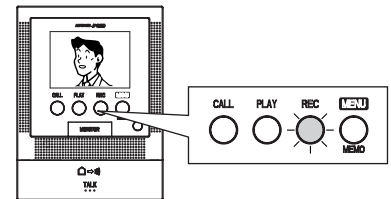

NOTES: 1. The automatic recording function cannot be cancelled.
2. The screen shown when monitoring the entrance is not recorded automatically. If you wish to record this screen, press REC button.

8-8 Manual recording

- 1 Display a video image with an operation such as entrance monitoring.
- 2 Press REC button. The record LED (red) flashes and recording starts.

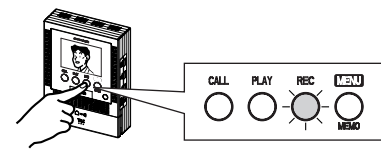
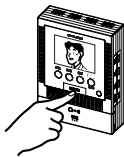

NOTES: 1. Manual recording is not possible during automatic recording (approx. 9 seconds after receiving a call from door station).
2. After the end of automatic recording (approx. 9 seconds have passed after receiving a call from the door station), another picture different from the automatically recorded picture is recorded.

- A maximum length of approx. 8 seconds (8 shots) can be recorded with 1 picture and 1 shot for each second.
- A maximum of 50 pictures can be recorded (combined total of automatic recording and manual recording pictures). If 50 pictures are exceeded, pictures are overwritten starting from the picture with the oldest recording date.

8-9 Play recorded picture

If there are automatically recorded pictures, such as those taken while you were out, the play LED (red) flashes.

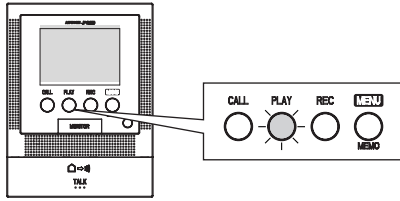

1 Press PLAY button in the standby mode to display the play screen.

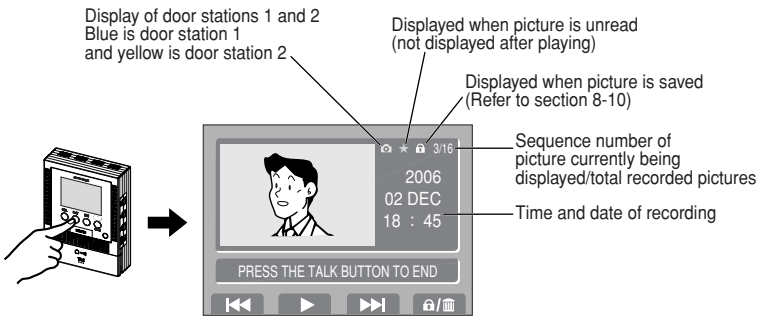

2 Press PLAY button on the play screen. The recorded picture is played. When the play of 1 picture ends, the next image is displayed.

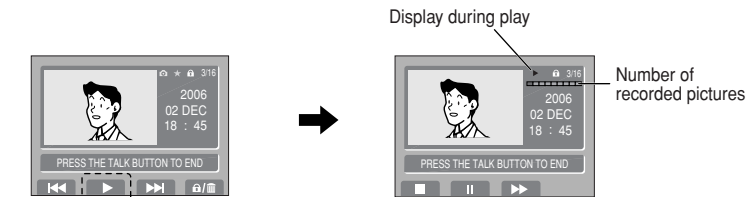

3 To advance the play frame-by-frame, press PLAY button during playback to pause. The play moves forward frame-by-frame each time REC button is pressed. When the frames of 1 picture end, the next picture is displayed.

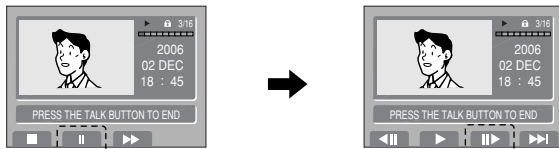

4 Press TALK button to end.

* In addition, the operations shown below are also possible in the play screen.

• CALL button:
To display the previous (more recent date) picture. When the button is pressed for 1 second or more, during the time that the button is pressed the first picture only of the dates can be checked in succession, from older to more recent dates.

• REC button:
To display the next (older date) picture. When the button is pressed for 1 second or more, during the time that the button is pressed the first picture only of the dates can be checked in succession, in the direction of the older dates.

• MENU/MEMO button:
To save or erase a picture. (Refer to sections 8-10 and 8-11)

⚠ When there are multiple unread pictures, all pictures enter the read condition even if only 1 picture is played, and the play LED goes off.

* The operations shown below are possible during play.

• CALL button:
To stop playing the picture and display the next picture.

• PLAY button :
To pause play.

• REC button:
To display the next picture after the end of fast forward playing.

* In addition, the operations shown below are also possible during pause.

• CALL button:
The play is reversed frame by frame each time the button is pressed. When the frames of 1 picture end, the unit returns to the play-waiting screen.

• PLAY button :
To return to the play screen.

• MENU/MEMO button:
To display the next picture in the play screen.

NOTES: 1. If there are no operations for approx. 1 minute or more, it will end automatically.

2. If a call is received from door station during play, the chime tone sounds and the play is forcibly ended.

8-10 Save recorded picture

10 pictures can be saved from the recorded pictures (maximum of 50 pictures). Saved pictures are not overwritten.

1 Display the picture that you want to save in the play screen. (Refer to section 8-9)

Press MENU/MEMO button to display the save/erase selection screen.



* In addition, the operations shown below are also possible in the save/erase selection screen.

• REC button:
To erase the display picture. (Refer to section 8-11)

• MENU/MEMO button:
To return to the play screen.

2 Press CALL button. If the picture is saved, the key symbol is displayed. If the picture has already been saved, the save is canceled. Each time CALL button is pressed, the operation switches between save and cancel.



NOTES: 1. "CANNOT SAVE" is displayed if the number of possible saves is exceeded. Cancel unnecessary saved picture.

2. Pictures that have had the save canceled are not erased, but they are overwritten if the number of recorded pictures is exceeded.

8-11 Erase recorded picture

It is also possible to erase saved recorded pictures. The erasure of recorded pictures is performed for each picture in turn.

- 1 Display the picture that you want to erase in the play screen. (Refer to section 8-9)
Press MENU/MEMO button to display the save/erase selection screen.



- 2 Press REC button.



- 3 Press CALL button to erase.
Press PLAY button to stop the erasure and return to the play screen.
⚠ Once a picture is erased, it cannot be restored.



8-12 Recording Voice memos JF-2MED

Voice memos for internal use can be recorded. A maximum of 3 memos can be recorded (maximum of approx. 15 seconds per memo).

- 1 Press MENU/MEMO button in the standby mode.

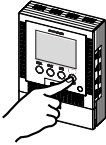

- 2 Select Voice memo with CALL button. Each time CALL button is pressed, the cursor switches between A, B, and C.

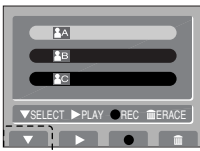

- 3 Press REC button to record a Voice memo.

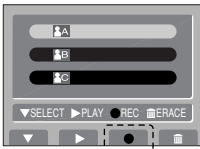

- 4 Press CALL button to end the recording. Alternatively, it ends automatically after approx. 15 seconds have passed.

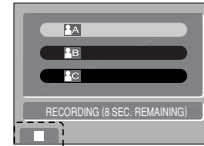

- 5 Press CALL button to check the recording results. Press PLAY button to stop the play and return to the Voice memo selection screen.

Unplayed symbol
Displayed for Voice memos that have never been played.

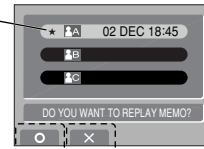

- 6 Press TALK button to return to the standby mode.

NOTES: 1. If a Voice memo with an unplayed symbol is selected and REC button is pressed the following is displayed: "DO YOU WANT TO OVERWRITE MEMO?" To overwrite press CALL button, and to abort press PLAY button.
2. The volume of Voice memos cannot be adjusted.

8-13 Playing Voice memos JF-2MED

If there are unplayed Voice memos, the memo LED (red) flashes.

- 1 Press MENU/MEMO button in the standby mode.

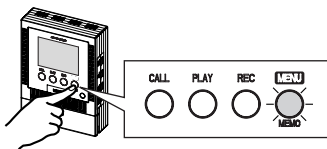

- 2 Select the Voice memo that you want to play with CALL button. Each time CALL button is pressed, the cursor switches between A, B, and C.

Unplayed symbol
Displayed for Voice memos that have never been played.

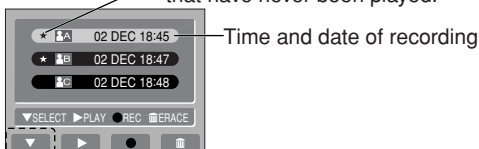

- 3 Press PLAY button to play a memo.



- 4 Press CALL button to end. Alternatively, it ends automatically after the playing finishes (maximum of approx. 15 seconds).

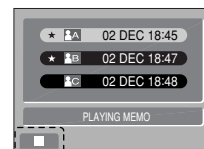

- 5 Press TALK button to return to standby mode.

NOTES: 1. When the playing ends the unit returns to the memo selection screen and the unplayed symbol goes off.
2. The volume of Voice memos cannot be adjusted.

8-14 Erasing Voice memos JF-2MED

1 Press MENU/MEMO button in the standby mode.

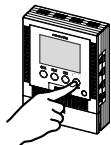

2 Select the memo that you want to erase with CALL button. Each time CALL button is pressed, the cursor switches between A, B, and C.



3 Press MENU/MEMO button.



4 Press CALL button to erase. Press PLAY button to stop the erasure and return to the Voice memo selection screen.

⚠ Once a Voice memo is erased, it cannot be restored.

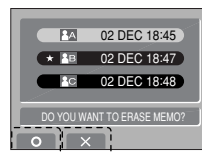

5 Press TALK button to return to the standby mode.

8-15 If optional units are installed

1 When a sensor is activated or a call button is pressed, the notification sound goes off and the transmit LED (red) flashes. A warning screen is displayed on the video monitor.

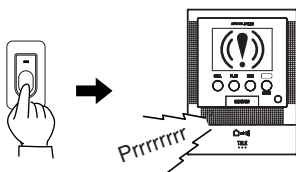



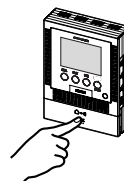

2 Press TALK button to stop the notification sound.

⚠ When the chime tone volume control is turned "Off", the notification sound does not go off. However, when the EXTERNAL SENSOR INPUT is set to , it sounds at a volume equivalent to "High" (fixed).



NOTES: 1. The notification sound time is set in the EXTERNAL SENSOR INPUT. (Refer to section 7-9)

The factory setting is .

2. When the EXTERNAL SENSOR INPUT is set to , door station 1 also emits a notification sound. (Door station 2 does not go off a notification sound.)
3. If a call is received from an entrance during the notification, the unit switches to the entrance call (communication is prioritized). However, when the EXTERNAL SENSOR INPUT is set to , the notification continues to sound even if there is a call from an entrance.
4. When the EXTERNAL SENSOR INPUT is set to , there is automatic restoration after 30 seconds.

9 TECHNICAL PRECAUTIONS

- Operating temperature: 0 °C to 40 °C (+32 °F to +104 °F)
- The video image may distort slightly during activation of door release. But this is not a unit malfunction.

- Cleaning: Clean the units with a soft cloth dampened with a neutral household cleanser. Do not use any abrasive cleaner or cloth.
- If there is a system malfunction, turn the Power switch at the monitor station OFF and back ON again. If this does not solve the problem, unplug the DC power supply and contact a qualified technician for service.

10 SPECIFICATIONS

- Power: DC 18 V (JF-2MED, JF-2HD)
- Current consumption: (Max.) 400 mA (JF-2MED)
(Max.) 220 mA (JF-2HD)
- Calling: Chime and image, approx. 45 seconds
- Communication: (HANDS-FREE mode) Approx. 60 seconds
(PTT mode) Press-to-talk, release to listen, approx. 60 seconds
- Video monitor: 3-1/2" direct view TFT color LCD
- Scanning lines: 525 lines
- Door release contact: AC/DC 24 V, 0.5 A (N/O dry closure contact L, L)
(Aiphone's EL-9S is recommended.)
- Dimensions: 179 (H) x 135 (W) x 32 (D) (mm)
7" H x 5-5/16" W x 1-1/4" D
- Weight: 500 g (1.1 lbs.) approx. (JF-2MED)
450 g (0.88 lbs.) approx. (JF-2HD)

WARRANTY

English

Aiphone warrants its products to be free from defects of material and workmanship under normal use and service for a period of two years after delivery to the ultimate user and will repair free of charge or replace at no charge, should it become defective upon which examination shall disclose to be defective and under warranty. Aiphone reserves unto itself the sole right to make the final decision whether there is a defect in materials and/or workmanship; and whether or not the product is within the warranty. This warranty shall not apply to any Aiphone product which has been subject to misuse, neglect, accident, or to use in violation of instructions furnished, nor extended to units which have been repaired or altered outside of the factory. This warranty does not cover batteries or damage caused by batteries used in connection with the unit. This warranty covers bench repairs only, and any repairs must be made at the shop or place designated in writing by Aiphone. Aiphone will not be responsible for any costs incurred involving on site service calls. Aiphone will not provide compensation for any loss or damage incurred by the breakdown or malfunction of its products during use, or for any consequent inconvenience or losses that may result.

This equipment has been tested and found to comply with the limits for a Class B digital device, pursuant to Part 15 of the FCC Rules. These limits are designed to provide reasonable protection against harmful interference in a residential installation. This equipment generates, uses, and can radiate radio frequency energy, and if not installed and used in accordance with the instructions, may cause harmful interference to radio communications. However, there is no guarantee that interference will not occur in a particular installation. If this equipment does cause harmful interference to radio or television reception, which can be determined by turning the equipment off and on, the user is encouraged to try to correct the interference by one or more of the following measures: • Reorient or relocate the receiving antenna • Connect the equipment into an outlet on a circuit different from that to which the receiver is connected. Increase the separation between the equipment and receiver. • Consult the dealer or an experienced radio/TV technician for help.

GARANTIE

Français

Aiphone garantit que ses produits ne sont affectés d'aucun défaut de matière ni de fabrication, en cas d'utilisation normale et de réparations conformes, pendant une période de deux ans après la livraison à l'utilisateur final, et s'engage à effectuer gratuitement les réparations nécessaires ou à remplacer l'appareil gratuitement si celui-ci présente un défaut, à la condition que ce défaut soit bien confirmé lors de l'examen de l'appareil et que l'appareil soit toujours sous garantie. Aiphone se réserve le droit exclusif de décider s'il existe ou non un défaut de matière ou de fabrication et si l'appareil est ou non couvert par la garantie. Cette garantie ne s'applique pas à tout produit Aiphone qui a été l'objet d'une utilisation impropre, de négligence, d'un accident ou qui a été utilisé en dépit des instructions fournies; elle ne couvre pas non plus les appareils qui ont été réparés ou modifiés en dehors de l'usine. Cette garantie ne couvre pas les piles ni les dégâts infligés par les piles utilisées dans l'appareil. Cette garantie couvre exclusivement les réparations effectuées en atelier. Toute réparation doit être effectuée à l'atelier ou à l'endroit précisé par écrit par Aiphone. Aiphone décline toute responsabilité en cas de frais encourus pour les dépannages sur site. Aiphone n'indemniser pas le client en cas de pertes, de dommages ou de désagréments causés par une panne ou un dysfonctionnement d'un de ses produits.

WAARBORG

Nederlands

Aiphone waarborgt zijn producten tegen materiaal- en fabricagefouten bij normal gebruik en onderhoud gedurende een periode van twee jaar na levering aan de eindgebruiker en zal het product kosteloos herstellen of vervangen indien na onderzoek blijkt dat het defect en nog onder waarborg is. Aiphone behoudt zich het recht voor als enige definitief te bepalen of er al dan niet sprake is van een materiaal-en/of fabricagefout en of het product nog onder waarborg is. Deze waarborg geldt niet voor om het even welk Aiphone-product dat is blootgesteld aan verkeerd gebruik, verwaarlozing, een ongeval of verkeerde bediening en evenmin voor toestellen die buiten de fabriek zijn hersteld of gewijzigd. Deze waarborg geldt niet voor batterijen of schade veroorzaakt door batterijen die in het toestel zijn gebruikt. Deze waarborg dekt uitsluitend werkbankherstellingen en iedere herstelling moet worden uitgevoerd in de schriftelijk door Aiphone aangewezen winkel of werkplaats. Kosten die gepaard gaan met herstellingen ter plaatse kunnen niet worden verhaald op Aiphone. Er kan geen schadeloosstelling van Aiphone worden geëist voor enig verlies of schade als gevolg van een defect of storing tijdens het gebruik van zijn producten, of voor enig ongemak of verlies dat hieruit voortvloeit.

 **AIPHONE**®

Providing Peace of Mind

<http://www.aiphone.com/>

AIPHONE CO., LTD., NAGOYA, JAPAN
AIPHONE CORPORATION, BELLEVUE, WA, USA
AIPHONE S.A.S., LISSES-EVRY, FRANCE

Printed in Thailand