



reddot design award
honourable mention 2009

Allround Easy. Allround Secure.



High-resolution 180° Panorama

High-resolution 180° Panorama

Version 09/06/Latest PDF file:
www.mobotix.com > Support > Manuals

HiRes

3 Megapixel2048 x 1536
Software zoom

Skyline

Format freeEach image format
freely definable**30 Frames/s**VGA (640 x 480)
30 F/s Mega**Virtual PTZ**Digital pan, tilt,
zoom**Backlight**Safe using CMOS
without mechanical iris**Internal DVR**Internal via SD card,
external via Network

Win/Lin/Mac

Recordingvia Network on PC
up to 1 Terabyte

Microphone & speaker

Audiobi-directional via IP,
variable framerates

SIP-Client with video

IP TelephonyAlarm notify,
cam remote control**VideoMotion**Multiple windows
precision pixel-based

-22°F ... +140°F

Weatherproof-30° ... +60°C, IP65,
no heating necessary

IEEE 802.3af

PoENetwork power
even in winter**Robust**No moving parts
fiber glass housing

McCC/Measy

Licence freeVideo-Management-
Software

HiRes Video Innovations

The German company MOBOTIX AG is known as the leading pioneer in network camera technology and its decentralized concept has made high-resolution video systems cost efficient.

MOBOTIX AG • D-67722 Langmeil • Tel: +49-6302-9816-103 • Fax: +49-6302-9816-190 • sales@mobotix.com

MOBOTIX Camera Data

Enter your camera data here.

Camera model:

Camera name:

Factory IP address:

Current IP address:

DHCP:

Admin user name:

Admin password:

Original Q24M image:
Wall mounted at a height
of 2.3 m in a bank

**Note**

MOBOTIX offers inexpensive seminars which include workshops and practical exercises: **Basic Seminar** three days, **Advanced Seminar** two days.

For more information, please visit www.mobotix.com

Foreword	6
The MOBOTIX Concept	8
Innovative Hemispheric Technology	10
MOBOTIX Hemispheric Technology	12
Superior Storage Solution	14
Added Security Value	16
Cost Benefits And Technical Advantages	18
1 INTRODUCTION	20
1.1 Q24M Overview	20
1.2 Q24M: Next Generation Hemispheric Technology	29
1.3 General MOBOTIX Camera Functions	30
1.4 Lens Options, Hardware And Software Features	36
2 INSTALLATION	40
2.1 Preparing The Installation	40
2.1.1 Wall-Mounted	41
2.1.2 Ceiling-Mounted	44
2.1.3 Mounting Options	47
2.1.4 Network Connection And Power Supply, UPS	48
2.1.5 Preparing The Camera Connections, Wall Outlets	49
2.1.6 Wiring, Fire Prevention, Lightning And Surge Protection	50
2.2 Q24M Basic/Secure: Delivered Parts, Components, Dimensions	52
2.2.1 Delivered Parts And Camera Components	52
2.2.2 Camera Housing And Connectors	53
2.2.3 Q24M: Dimensions Without Mounting Options	54
2.3 Available Q24M Accessories - Overview	56
2.4 Mounting The Camera Without Accessories	60
2.4.1 Mounting Instructions	60
2.4.2 Required Tools	61
2.4.3 Procedure	62
2.5 Mounting The Camera With The On-Wall Set	66
2.5.1 Mounting Instructions	66
2.5.2 On-Wall Set	67
2.5.3 Procedure	70

2.6	Mounting The Camera With The In-Ceiling Set	72
2.6.1	Mounting Instructions	72
2.6.2	In-Ceiling Set	73
2.6.3	Procedure	76
2.7	Installing The Vandalism Set	78
2.7.1	Mounting Instructions	78
2.7.2	Vandalism Set	79
2.7.3	Procedure	82
2.8	Installing The Wall Mount	84
2.8.1	Mounting Instructions	84
2.8.2	Wall Mount	85
2.8.3	Procedure	88
2.9	Installing The Corner And Pole Mount	90
2.9.1	Mounting Instructions	90
2.9.2	Corner And Pole Mount	91
2.9.3	Mounting To A Pole	93
2.9.4	Mounting To A Wall Or Building Corner	94
2.9.5	Mounting The Wall Mount To The Corner And Pole Mount	95
2.10	Replacing The MicroSD Card	96
2.10.1	Removing The MicroSD Card	96
2.10.2	Inserting A MicroSD Card	97
2.11	Network And Power Connection	98
2.11.1	Notes On Cable Lengths And Power Supply	98
2.11.2	PoE Variables	98
2.11.3	Power Supply Using A Switch	99
2.11.4	Power Supply When Connected Directly To A Computer	100
2.11.5	Power Supply (PoE IEEE 802.3af) Using Power-over-Ethernet Products	100
2.11.6	Camera Startup Sequence	101
3	OPERATING THE CAMERA	102
3.1	Manual And Automatic Operation - Overview	102
3.1.1	Manually Using A Computer In The 10.X.X.X IP Address Range	103
3.1.2	Automatically Using MxControlCenter Or MxEasy	104
3.1.3	Automatically Using DHCP	105
3.2	First Images And The Most Important Settings	106
3.2.1	Manually Setting Up The Network Parameters In A Browser	106
3.2.2	First Images And Configuration In The Browser	108
3.2.3	First Images And Network Parameter Configuration In MxControlCenter	110
3.2.4	First Images And Network Parameter Configuration In MxEasy	116
3.2.5	Starting The Camera With An Automatic IP Address (DHCP)	120
3.2.6	Starting The Camera With The Factory IP Address	121

3.3 Virtual PTZ And Special Q24M Configuration	122
3.3.1 Preparing The Virtual PTZ Function	122
3.3.2 Special Q24M Configuration In The Browser	124
3.3.3 Overview Of The Available Camera Views	130
3.4 MicroSD Card Recording	134
3.4.1 Introduction	134
3.4.2 Formatting The Card	136
3.4.3 Activate Recording:	137
3.4.4 Accessing Camera Data	138
3.4.5 Deactivating The Card Memory	138
3.4.6 Using A MicroSD Card In A Different MOBOTIX Camera	139
3.4.7 Limitations On Warranty When Using Flash Storage Devices	139
3.5 Q24M Storage Options - Full Image Storage	140
3.6 Further Configuration In The Browser	142
3.6.1 Overview	142
3.6.2 General Browser Settings	142
3.6.3 Additional Configuration Options	145
3.7 Additional Notes	146
3.7.1 Weatherproof Qualities	146
3.7.2 Password For The Administration Menu	146
3.7.3 Permanently Deactivating The Microphone	146
3.7.4 Starting The Camera With The Factory IP Address	147
3.7.5 Reset The Camera To Factory Settings	147
3.7.6 Activate Event Control And Motion Detection	147
3.7.7 Deactivate Text And Logo Options	147
3.7.8 Deactivating The Daily Automatic Camera Reboot	148
3.7.9 Browser	148
3.7.10 Cleaning The Camera And Lens	148
3.7.11 Safety Warnings	149
3.7.12 Additional Information	149

Notes and Copyright Information

The enclosed **Camera Software Manual** contains detailed information on the camera software. Download the latest version of this manual and the MxEasy and MxControlCenter manuals as PDF files from www.mobotix.com (Support > Manuals).

All rights reserved. MOBOTIX, MxControlCenter, MxEasy, ExtIO and CamIO are internationally protected trademarks of MOBOTIX AG. Microsoft, Windows and Windows Server are registered trademarks of Microsoft Corporation. Apple, the Apple logo, Macintosh, OS X and Bonjour are trademarks of Apple Inc. Linux is a trademark of Linus Torvalds. All other brand names mentioned herein may be trademarks or registered trademarks of the respective owners. Copyright © 1999-2009 MOBOTIX AG, Langmeil, Germany. Information subject to change without notice!

Additional Information:
www.mobotix.com

FOREWORD

Dear MOBOTIX customer,

Congratulations on purchasing this globally unique and discreet hemispherical network camera "Made in Germany". With its wide range of image display options such as the panorama function, a virtual PTZ function and live distortion correction, the Q24M offers whole new application possibilities. Proven MOBOTIX concept advantages such as integrated event, alarm and telephony functions, as well as modern and highly beneficial long-term flash storage located directly in the camera, are also available.

This Camera Manual Part 1 will give you an initial overview of the innovative underlying MOBOTIX concept. This includes all the information you need to unpack and install the camera (Chapter 2) and to view initial images on a PC (Chapter 3).

Please see the Software Camera Manual Part 2, included in the camera packaging, for information on how to work with the many camera functions, such as e.g. event control or image storage.

If you would prefer to work with **MxEasy** or **MxControlCenter** instead of the browser controlled MOBOTIX camera software, you can download these programs for free including a manual (PDF) from the MOBOTIX website:

www.mobotix.com/eng_US/Support/Software-Downloads

If you have any questions, our support and international sales staffs are available under intl-support@mobotix.com from Monday to Friday, 8 a.m. to 6 p.m (German time).

We would like to thank you for your trust and wish you all the best with your new MOBOTIX camera!



Security-Vision-Systems





Q24M with 10°
On-Wall Set

Q24M in the
In-Ceiling Set

THE MOBOTIX CONCEPT

HiRes Video Innovations

The German company MOBOTIX AG is known as the leading pioneer in network camera technology since its founding in 1999, and its decentralized concept, has made high-resolution video systems cost efficient. Whether in embassies, airports, railway stations, ports, gas stations, hotels or on highways - over one hundred thousand MOBOTIX video systems have been in operation on every continent for years.



Technology Leader Of Network Cameras

In a short time, MOBOTIX has gained the second place in Europe and the fourth place worldwide in terms of market share. MOBOTIX has been solely producing megapixel cameras for years and, in this area, ranks as global market leader in high-resolution video systems with a market share of over 60%.

Why High-Resolution Systems?

The higher the resolution, the more accurate the detail in the image. With the old analog technology, a live image has no more than 0.4 megapixels and a recorded image generally 0.1 megapixels (CIF). On the contrary, one MOBOTIX camera with 3.1 megapixels records around 30 times more detail. As a result, larger image areas with up to 360° allround views are possible, thus reducing the number of cameras and therefore the costs. For example, four lanes of a gas station can be recorded with one MOBOTIX camera instead of four conventional cameras.

Disadvantages Of Old Centralized Solution

Usually cameras only supply the images while the processing and recording is done later on a central PC using video management software. This traditional centralized structure has many limitations, since it requires a high network bandwidth and the PC processing power is not enough for several cameras. A HDTV MPEG4 film already puts considerable strain on a PC, how can it be expected to process dozens of high-resolution live cameras? Traditional centralized systems are therefore less suitable and unprofitable than high-resolution systems due to the high number of PCs needed.

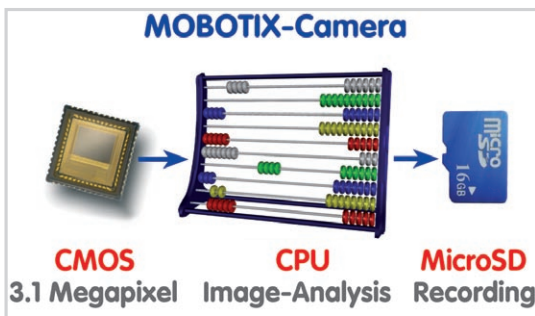

The Decentralized MOBOTIX Concept

Unlike with other systems, with the decentralized MOBOTIX concept a high-speed computer and, if requested, digital memory (MicroSD/SD card) is built into every camera for long-term recording. The PC now serves purely for viewing, not for analysis or recording. As a result, MOBOTIX cameras can record in response to an event even without the PC being switched on and digitally store the videos with sound.

The Benefits

MOBOTIX video solutions therefore require significantly:

- **fewer cameras** due to the more accurate detail of panoramic images with mega-pixel technology,
- **fewer PCs/DVRs**, because around 40 cameras can store high-resolution videos with sound efficiently on a single PC, or no PC at all when recording in the camera using digital memory (USB, MicroSD/SD card),
- **lower network bandwidth**, because everything is processed in the camera itself and the high-resolution images therefore do not have to be constantly transported for analysis.

Robust And Low-Maintenance

MOBOTIX cameras have no mechanical motors for lenses or for movement. Without any moving parts, they are therefore so robust that maintenance is reduced to a minimum. The unique temperature range from -30°C to $+60^{\circ}\text{C}$ is achieved without heating or fan at approximately 3 watts. Since no PC hard disk is required for recording, there are no parts that wear out in the entire video system.

Software Included - For Life

There are no software and licensing costs with MOBOTIX, because the software is always supplied with the camera; for an unlimited number of cameras and users. The software package supplied with the camera also includes professional control room software, like that used in football stadiums, for example. Updates are supplied free of charge on the website. The system price for a weatherproof camera including lens, query software and day-to-day recording on the MicroSD/SD card is under 1,000 euro.



INNOVATIVE HEMISPHERIC TECHNOLOGY

The Hemispheric Camera

The primary components of the hemispheric camera include a fisheye lens, a high-resolution image sensor and image correction software that is integrated into the camera. Using an ultra-wide angle fisheye lens, the camera captures a 180° hemispheric image of the room and projects it onto a high-resolution image sensor.



A Fisheye Perspective

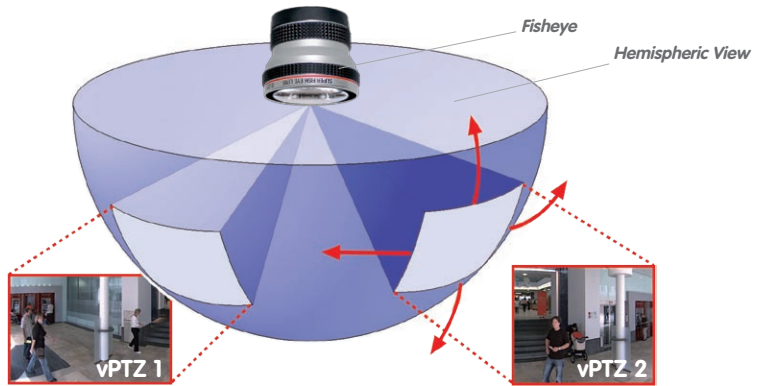

When ceiling mounted, the image area of the hemispheric camera covers the entire room. The image in the hemisphere is convex, particularly near the image borders. These image sections are corrected for the viewer by the integrated distortion correction software, allowing a view of the scene from the usual perspective. The **virtual PTZ feature** allows you to enlarge or move image sections within the hemisphere, just like a PTZ camera yet, with MOBOTIX, this is achieved with no moving parts.

Handle Several Image Sections At Once

One or more image sections can be corrected for perspective in the hemispheric view, allowing you to monitor and record several different areas of a room **at the same time**, something that a mechanical PTZ camera is not capable of doing.



Q24M in the In-Ceiling Set

Discreet And Low Maintenance

Hemispheric cameras are extremely discreet because they manage their task with only **one lens**, which is generally focused on the entire room and not a specific object. MOBOTIX hemispheric cameras are without mechanical moving parts and require low maintenance. In addition, they are silent when panning and focusing on a specific image area.

Less Cameras Thanks To Panoramic Views

The perspective of the hemispheric image can also be transformed into an ultra-wide angle panoramic view spanning 180° if the camera is mounted on a wall, providing a wall-to-wall view of the room without any blind spots. It offers a substantially better view of the scene, compared to other cameras, it also results in the need for fewer cameras overall. When ceiling mounted, one camera can also capture an entire room by two opposite panoramic views.

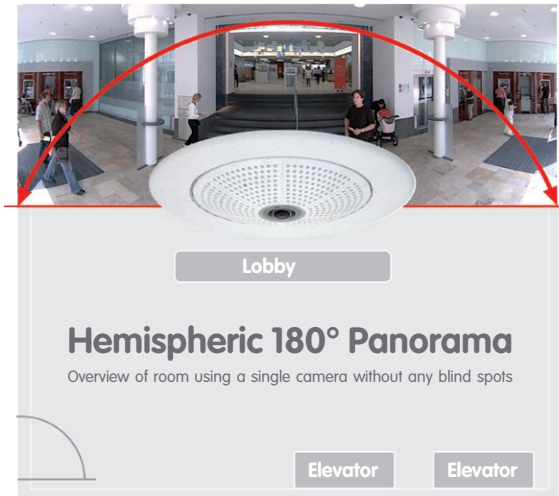

Original Q24M image:
Wall mounted at a
height of 2.3 m



Hemispheric room coverage for a wall mounting – one Q24M replaces four standard cameras

Keeping Objects In View At All Times

Using solutions featuring several individual cameras, moving objects will normally jump from one viewing area of a camera to another. This often produces a confusing situation for the viewer because objects may disappear from sight for a moment or even appear twice if the viewing areas overlap. This is not the case with hemispheric panoramic cameras. Objects remain in view at all times and the viewer can always keep good track of objects in the scene.

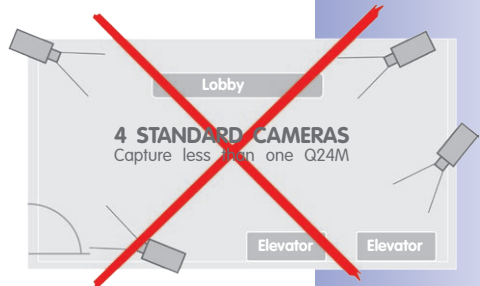

Everything Stored In The Recording

In contrast to a normal PTZ camera, which is always focused on one section of a room and only records that section, the virtual PTZ also allows you to pan to other areas at a later stage in the recording as the **entire room** can be recorded as a hemispheric image.



Integrated
MicroSD/SD card
(up to of 32 GB)

MOBOTIX HEMISPHERIC TECHNOLOGY

Perfect Room Overview

With the innovative MOBOTIX Hemispheric Technology, an entire room can be ideally monitored. For instance, one single, particularly elegant and discreet, Q24M replaces the time-consuming and expensive installation of several standard cameras. This world first demonstrates again the innovative strength of MOBOTIX as a global leader for megapixel video security systems.



High-Resolution 180° Panorama

When several cameras are monitoring a single room, it is difficult to understand the room layout in its single view. This makes it hard to comprehend the overall setting. The new panorama function of the Q24M delivers a widescreen image of a high-resolution 180° allround view. High image quality is achieved through the use of a 3.1 megapixel sensor and the new hemispheric lens.



Original Q24M image:
Wall mounted at a height
of 2.3 m in a bank

Virtual PTZ (vPTZ) – Without Motor

The Q24M also zooms in on detail. The image of the Hemispheric camera can be continuously enlarged and any image section examined using a joystick, for example. Thus you have a mechanical PTZ-camera without maintenance or wear and tear. While zooming into a section in the live image, a full image can be stored in the recording for later analysis. No PTZ-camera in the world that operates with a motor can do that!



vPTZ control, also
using a USB joystick

One Camera, More Views

The surround function of the Q24M (ceiling mounted) immediately replaces four conventional cameras and shows four different directions simultaneously in quad view on a monitor. Virtual PTZ is available for each of the four views. Together with the 180° panorama the Q24M can deliver two more views simultaneously, making it possible to see the overview and to focus on two scenes at the same time (Display Mode "Panorama Focus").

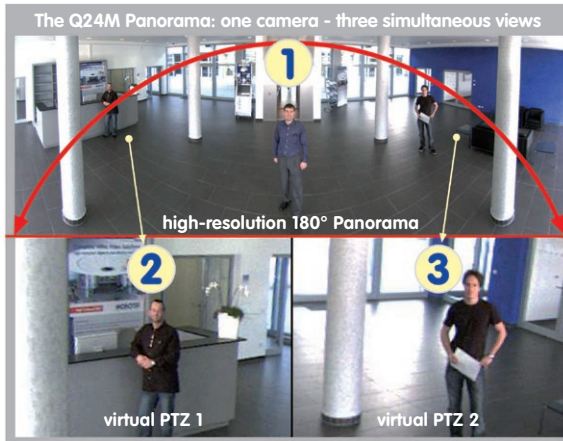

Panorama Focus:
Original Q24M image

Highly User-Friendly

The full image from a hemispheric lens (Fisheye) is difficult to analyze. MOBOTIX solves this problem by perfectly straightening the uneven lines in the live image using the camera software. Since the image distortion correction of the hemispheric view and the generating of the panoramic view take place in the camera itself, no additional load is placed on the viewer PC, unlike a "standard" camera. Thus, displaying a large number of panoramic cameras simultaneously on a single PC is possible.

Highly Efficient Image Transferring

While other camera systems always transfer the full images via the network for further analysis, a MOBOTIX camera sends only the relevant image sections. Therefore, a Q24M panorama image needs only about 1/6 of the original data volume or bandwidth. This means up to six times more MOBOTIX cameras can transfer images over a network compared to "standard" cameras.

Internal DVR With 32 GB

The Q24M stores high-resolution video with sound directly on the integrated Flash memory without using an external recording device or PC, therefore using no additional network load. Old recordings can be overwritten automatically or deleted after a predefined period. The storage capacity is sufficient for around 400,000 panorama images or 33 hours of film (32 GB MicroSD).

SUPERIOR STORAGE SOLUTION



The Market Demands Better Image Quality

When it comes to future-proof video surveillance systems, it is not a matter of analog or digital but whether it is high-resolution or not. It is important to note that HiRes video only with decentralized network camera technology can be implemented at much lower cost than any other type of video surveillance system.

Central Storage As A Bottleneck

These days, video data is normally pre-processed and stored centrally on a PC or DVR using video management software. Video and audio streams from all installed cameras are directed to this central device. This system is comparable to a highway at rush hour: the more cameras there are, the faster a data jam on the PC or DVR occurs. This means that despite HiRes cameras, the data is generally not stored in high-resolution format.

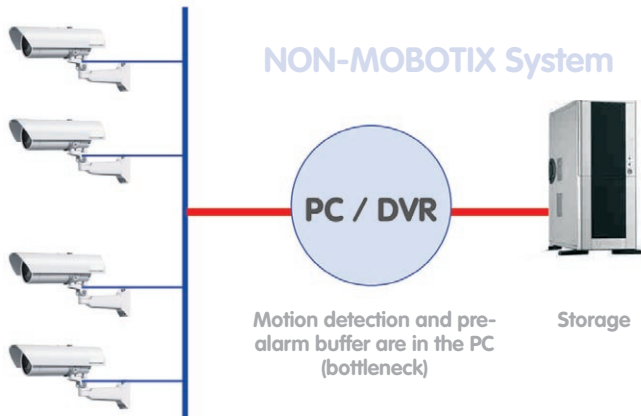

Central PC is a bottleneck and a risk for the total system

MOBOTIX Stores HiRes Cost Efficiently

MOBOTIX solves the PC storage bottleneck problem using a unique and yet amazingly effective method - through the camera itself. High-resolution video with lip synchronized sound is saved either remotely over the network or locally on flash memory devices (commercial SD or CF cards, USB memory).

Flash memory is a sophisticated form of semiconductor memory without mechanical moving parts and represents the storage medium of the future thanks to its reliability, ease of use and low cost.



Software and storage integrated in MOBOTIX cameras

MOBOTIX Stores Data In Flash Memory

- No PC / network is needed for operations and there is no network load
- USB flash media can be connected directly to the camera (instead of internal SD/ MicroSD/CF card); no network is necessary
- Greater reliability (no hard disk drive)
- Ring buffer: Old images can be overwritten automatically or deleted after a specified time

MOBOTIX Stores Data Reliably

MOBOTIX' own flash file system (MxFFS) prevents unauthorized persons from reading or transferring the internally stored data, even if the card is stolen.

Mobotix Only Saves What Is Necessary

The MOBOTIX system includes three important additional options that allow more data to be stored for a longer time:

- Only the relevant image sections are stored instead of the entire image (for example, sky or ceiling is removed)
- Video recording only begins when relevant events take place (such as movement in the image)
- Temporarily increased frame rate during continuous recording of events

By connecting external memory over the network (NAS), the system can be expanded without limitations even while it is running.

MOBOTIX Data Storage

- **Inside the camera** - one MicroSD card is enough to record all day long, making central data storage devices or PCs unnecessary
- **in USB memory** (connection via USB cable) data storage without mechanical moving parts or network load (greater protection against data theft)
- A **file server (NAS)** can store around 10 times more data from MOBOTIX HiRes cameras (than usual) since they use a memory organization internally

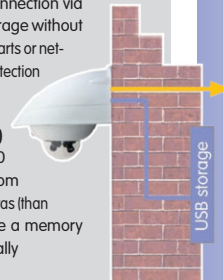

ADDED SECURITY VALUE

Q24M Panorama: one camera - three simultaneous views



Robust, Low-Maintenance Technology

The real added value of MOBOTIX products is reflected in characteristics such as enhanced functionality, **long life and robustness**. MOBOTIX cameras basically have no moving parts. This makes the cameras very resistant to wear and tear, and reduces both maintenance costs and power consumption.

Alarm Management And Forwarding

Integrated sensors enable MOBOTIX cameras to recognize when an event has occurred. If necessary, the cameras will respond immediately with an alarm tone and will establish a direct video and sound connection to a control room.

Absolute Data Security

The security barriers that are built into the camera are extremely secure. The camera images are only accessible to authorized persons and are encrypted via SSL when they are transferred over the network.

Notification Of Failure

MOBOTIX cameras will automatically report any impairment or failure. This ensures maximum reliability and readiness for use.

Subsequent Searches

Events rarely confine themselves to just one spot. So even when you are looking at an enlarged detail in live mode, it is always a full image that is recorded. And in this full image, any section can always be enlarged later or whenever necessary.

Floor plan and camera view in MxControlCenter (free control center software from MOBOTIX)



Sound Increases The Chance Of Detection

In the event of an alarm, MOBOTIX cameras can turn on their built-in microphones and record lip-synchronous sound. They are therefore an even greater help in analyzing a situation and easing clarification. In addition, the video system can be used for bidirectional communication via a loudspeaker/microphone.

No Problems With Backlight

MOBOTIX cameras are not affected adversely by sunlight such as direct sunlight. They deliver meaningful, detailed images all the time, because the camera software supports easy programming of independent **exposure windows** to cope with specific situations. This makes them ideal for rooms with large glass fronts.



Placing the exposure window in the lower image area (left image) delivers less optimum results compared to moving three individual exposure windows up toward the windows (right image)

Vandalism-Proof Models

In critical environments or for outdoor use, it is often best to choose vandalism-proof MOBOTIX cameras. Their steel housing resists even the hardest attacks, and the cameras will deliver a perfect picture of the attackers.



THE MOST IMPORTANT COST BENEFITS

- 1 Increased resolution reduces amount of cameras needed**
1536-line, high-resolution sensors give a better overview and allow monitoring an entire room with just one camera from the corner
- 2 Reduced installation costs at any distance**
Standard Ethernet connection enables the use of use of common network components such as fiber, copper and wireless (WLAN)
- 3 Intelligent recording technology reduces required storage**
Decentralized recording technology in the camera software puts less strain on PCs and reduces the amount of storage PCs (DVRs) by 10 times
- 4 Event-controlled image rate minimizes storage costs**
Event-driven, automatically adjusted recording frame rate based on event or sensor action reduces amount of data and storage costs
- 5 No additional power and no heating required**
Anti-fogging without heating allows usage of standard PoE technology to power the system via network and saves costs of power cabling
- 6 Backup power requirement reduced by 8 times**
Low power consumption, approx. 4 watts, enables year-round (no heating required) PoE with one centralized UPS from installation room via network
- 7 Robust and practically maintenance free**
Fiberglass-reinforced composite housing with built-in cable protection and no mechanical moving parts (no auto iris) guarantees longevity
- 8 No software and no licence costs**
Control and recording software is integrated in the camera and is free of charge; new functions are available via free software downloads
- 9 Unlimited scalability and high return of investment**
While in use, more cameras and storage can be added at any time; image format, frame rate & recording parameters can be camera specific
- 10 Additional functions and other extras included**
Audio support, lens, wall mount and weatherproof housing (-30° .. 60°C; -22° .. 140°F) are included; microphone & speaker available in certain models

THE MOST IMPORTANT TECHNICAL ADVANTAGES

Progressive-scan instead of half-frame blur

Megapixel sensor and image processing inside camera with digital white balance generates sharp and true color images at every scale

1

Sun and backlight compensation

CMOS-sensor without auto iris, digital contrast enhancement and configurable exposure measurement zones guarantee optimal exposure control

2

Dual camera technology: 2-in-1

Two possible camera views with picture-in-picture technology or 180° panoramic view; one Dual-Fixdome camera with 2.5 megapixel is enough

3

Long-term, high-performance Terabyte recording included

Event detection and ring buffer recording by the camera itself allow recording of 40 smooth video streams on a single PC (1200 VGA images/s)

4

Simultaneous recording, event search and live viewing

Live video for multiple users, recording and event search simultaneously possible in seconds from anywhere in the world via network

5

Very low network load

Efficient MxPEG video codec, motion detection based recording and video buffering inside camera guarantee a very low network load

6

Bridging of recording during network failures

Internal camera ring buffer bridges network failures and bandwidth fluctuations of wireless links (WLAN/UMTS) for several minutes

7

Day & night maintenance free

Unique Day/Night camera technology without moving parts guarantees extreme light sensitivity and ensures long-term reliability

8

Audio and SIP telephony

Lip-synchronized audio (live & recording); each camera is a video IP telephone based on SIP standard with automatic alarm call and remote control

9

MxControlCenter included

Dual screen technology with building plans, free camera positioning, event search, image processing, lens distortion correction and PTZ support

10

1 INTRODUCTION

1.1 Q24M Overview



Innovative Hemispherical Technology For The Perfect Room Overview

The MOBOTIX Q24M Hemispheric camera is an elegant, ultra-compact and weather proof IP network dome camera with a special hemispheric lens (fisheye). When mounted on the ceiling, the camera is capable of providing full **360° allround view** or a **180° panorama** when mounted on a wall. The first of its kind in the world, this camera is evidence of the MOBOTIX commitment to innovation as the global leader in megapixel video security cameras.

High-resolution 180° Panorama (Wall-Mounted)

When several cameras are monitoring a single room, it is difficult to understand the room layout due to the different viewing directions of each camera. This makes it hard to comprehend the overall setting. The new panorama function of the Q24M delivers a widescreen image of a high-resolution 180° allround view. High image quality is achieved through the use of a 3.1 megapixel sensor and the new hemispheric lens.

Original Q24M image;
Wall mounted at a height
of 2.3 m in a bank



Original full image



High-resolution 180° Panorama

Panorama Focus – One Camera, Three Views (Wall-Mounted)

Maximum room overview while simultaneously viewing detail in a single image: the Q24M is capable of providing two more views at the same time with the 180° panorama, allowing you to focus on two scenes in parallel ("Panorama Focus" display mode).

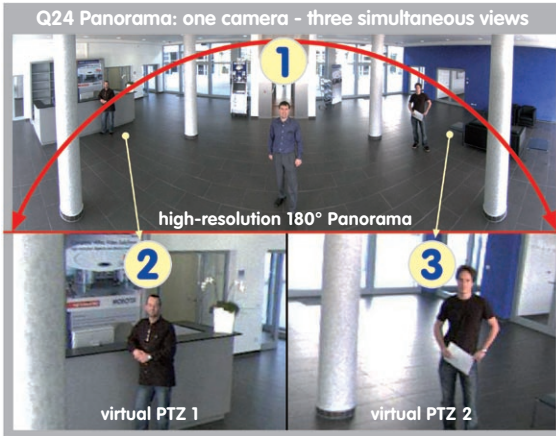

Panorama Focus:
Original Q24M image



Original full image

Double Panorama For A Simultaneous View In Two Directions (Ceiling-Mounted)

When the camera is mounted in the center of the ceiling of a room, "Double Panorama" display mode provides a corrected panorama image of both halves of the room. It corresponds roughly with the situation of personally standing in the middle of the room and being able to look both forwards and backwards at the same time. A superb overview for the user – provided by a single Q24M camera alone.



Double Panorama:
Original Q24M image



Original full image

Full Image And Normal View

With innovative MOBOTIX Hemispheric Technology, an entire room can be ideally monitored. For instance, one single, particularly elegant and discreet, Q24M replaces the time-consuming and expensive installation of several standard cameras. The overview image provided by a single Q24M, which may be tailored in a number of ways according to specific user requirements, not only reduces the number of required cameras, but also minimizes the system costs by reducing the wiring complexity, emergency power requirements and number of recording devices required.

In addition to Panorama, Double Panorama and Panorama Focus views, the Q24M image may be displayed on a monitor in the original fisheye version ("Full Image" display mode), the camera-corrected full image ("Normal" display mode) or in a quad view of all four directions ("Surround" display mode). Switching to a different display mode is possible at any time within seconds.



Surround View (Quad View), Based On The Correct Full Image

The Q24 "Surround" display mode replaces (when ceiling mounted) four cameras, and shows four directions simultaneously on the monitor in a quad view. The preset North position can be moved to any direction in the image; the camera generates the other three directions (East, South, West) automatically and stores them as separate views.

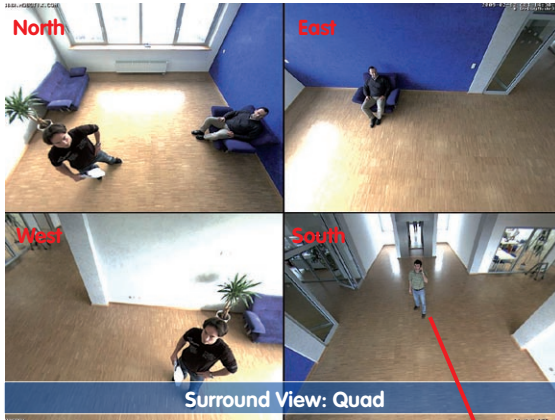

Original Q24M image:
Each of the 4 views can be individually modified

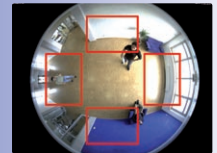

Original full image

Each of the four views features a software-controlled pan/tilt/zoom function (virtual PTZ), allowing it to be customized as necessary.

In order to reduce user workload, the Q24M can store in addition to the North, East, South and West standard views, a total of **256 user-defined camera views using the vPTZ function**, which can easily be brought up using joystick keys or softbuttons. Besides being able to manually bring up specific camera views, the camera can also show them automatically by moving through the North, East, South and West views or by showing the first 16 saved camera views (one after the other like in a slide show).



Virtual PTZ (vPTZ) – No Motor Required

The Q24M can zoom in on detail as well. These vPTZ functions are a standard feature in the integrated Q24M camera software. The image from the hemispheric camera can be enlarged using e.g. the mouse wheel, a joystick or a software-controlled PTZ panel, and you can "move" the view to any section of the image. This provides the features of a mechanical PTZ camera without the disadvantages of maintenance and wear.



Quick and easy navigation with a USB joystick

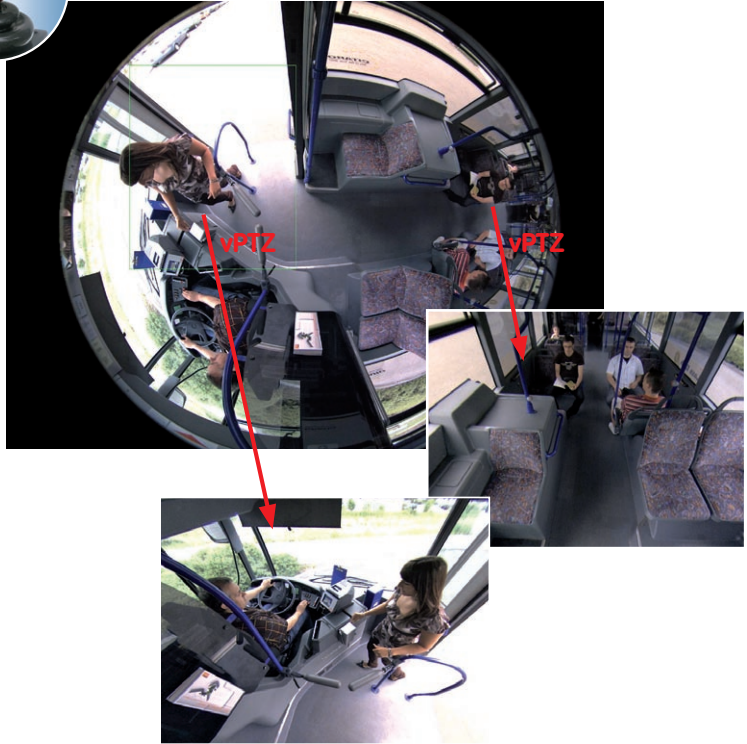

The vPTZ functionality works differently depending on the camera operation platform (**web browser, MxEasy, MxControlCenter**). Virtual zoom, pan and tilt using MxEasy and MxControlCenter is very simple thanks to special software tools and the use of an optional joystick. However, a joystick may also be used even with pure browser-based operation from Internet Explorer (together with an ActiveX plug-in).

Simultaneous Corrected Live Image And Full Image Recording

All conventional, motorized PTZ cameras only store the image that is currently viewed as the live image (**live image recording**). This has one serious disadvantage as the recording can only show what has happened in the "visible" portion of the image; the rest is lost and cannot be examined later on. For this reason, MOBOTIX has added the new **full image recording** feature to the Q24M. This will not store the currently viewed image that reflects the pan/tilt position and the zoom setting chosen by the user, but the full sensor image - without vPTZ settings or image correction. When examining the recorded images at a later point in time, the vPTZ features again come into play, as they allow zooming the visible image and use the pan/tilt features to examine every corner of the recorded full image.

Example: The people marked by the red circle in the middle area of the image would not have been recorded by a regular PTZ camera; the full image recording of the Q24M allows to determine for example, the exact time at which the people entered the image area recorded by the camera. A **Browser** (Internet Explorer with MxPEG ActiveX plug-in), **MxControlCenter** or **MxEasy** can be used to examine the recorded sequences.

Integrated vPTZ functions allow "analysis" of the complete saved full image at a later point in time (in MxEasy and MxControlCenter)

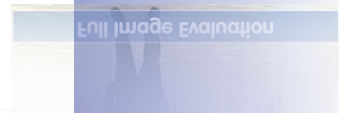
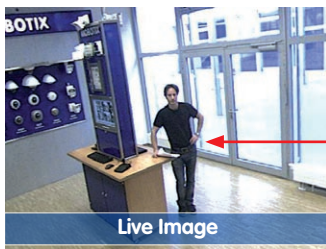

The camera software is responsible for image correction, reducing load on the user PC

Maximum Ease Of Use

The full image generated by the hemispherical lens (fisheye) can be difficult to evaluate. MOBOTIX solves this problem with image distortion correction in the camera software that displays perfectly corrected live images. The user PC does not experience any additional load through this process, as image correction and generation of all desired image views takes place in the camera itself. The result is that a large number of panoramic cameras may be displayed simultaneously on a single PC.

Highly Efficient, Application-Oriented Image Transfer

While other camera systems must transport the full 3.1 megapixel image over the network for further processing, a MOBOTIX camera will only transmit the desired image sections. This means that a Q24M panorama image will only require a small part of the usual data and bandwidth. Data from up to six times as many MOBOTIX cameras may be transported over the same network compared to "standard" cameras.



Corrected image after panorama correction

Economical bandwidth usage due to smaller, in-camera corrected images (no loss of image information)

Internal DVR

The Q24M SECURE model features **direct recording to integrated MicroSD cards**, which makes the camera fully independent of any external storage media, even for longer periods of time. The camera internally saves high-resolution video and audio, without requiring an external storage device or PC or overloading the network whatsoever. Old recordings may be overwritten automatically or deleted automatically after a specified period of time. A 16 GB MicroSD card, for example, allows the camera to store more than a quarter million event images in VGA format (640 x 480). For security reasons, the camera can even encrypt the stored data.



4 GB MicroSD card preinstalled in the camera (Q24M-Secure)

Power failures are not an issue, as the video and image sequences remain safely stored on the MicroSD card. Access to stored video sequences is possible at any time from the camera user interface in the browser, MxControlCenter or MxEasy. If you would like to archive sequences, you can store all of the data or only certain parts to a computer or external hard disk.

High Frame Rates Of Up To 30 fps

Like all other MOBOTIX cameras, the Q24M models can generate live video streams with high frame rates and a maximum image resolution of 3.1 megapixels (QXGA with 2048 x 1536 pixels). Up to 30 fps are generated at a megapixel resolution of 1280 x 960 pixels. Even at 3.1 megapixels, the camera will still generate up to 20 fps! And the audio playback is always lip-synchronous.

Robust And Maintenance-Free

Thanks to its low power consumption of approximately 3 watts and the total absence of mechanical moving parts, the Q24M models feature the highest operating temperature range from -30°C to +60°C (-22°F to +140°F). Both Q24M models (BASIC & SECURE) are absolutely dust proof to IP54, with the SECURE model being resistant against water jets (IP65) also. Since the cameras neither fog up nor require heating, power can be supplied all-year round via the Ethernet cabling using standard PoE products.

Camera Design Creates New Applications

Some application scenarios benefit from a surveillance camera that is present, but doesn't attract attention. The low-key elegance of the camera's design, especially when installed with the In-Ceiling set, makes the Q24M the ideal solution for the intersection of discreet design and inconspicuous look. For example, hotels and restaurants—not to mention installations in public buildings, waiting rooms, and showrooms—present a suitable backdrop for this type of equipment.

The integrated DVR functionality with long-term storage on a MicroSD card also makes the camera an ideal solution for **mobile applications** since it only requires a power supply via the network cable (standard PoE) for full event-driven recording with video and audio, thus delivering a complete **standalone product**. Application examples in this context are installations in public transportation such as busses, trains, aboard ships, airplanes, etc.

Q24M in the In-Ceiling Set (local public transport bus)



Q24M in the In-Ceiling Set with stainless steel ring (elevator)



Model Versions

The Q24M is available in **Secure and Basic models**, which come with different features. Both models can also be ordered with an L22 Super Wide-Angle lens with a horizontal image angle of 90°.

1.2 Q24M: Next Generation Hemispheric Technology

The Q24M Hemispheric camera is the more powerful and optimized successor to the Q22M and is delivered with a recording capacity of 4 GB integrated as standard. The Q24M has a new microprocessor and a modified system platform. The result is more than twice the processing power, which enables smooth video frames rates, even in the high-resolution 180° panoramic view. In one of the most renowned and competitive international design competitions, the Hemispheric camera was the first security and surveillance camera to receive the red dot award.



reddot design award
honourable mention 2009

Frame Rates Have Doubled

Even 3.1 megapixel camera images may be transferred at a rate of 20 frames per second, and megapixel images at up to 30 images per second.

User-Friendly Panorama Correction

In the standard "Panorama" view, the user may now switch between customized views of the live image at the click of a button.

4 GB MicroSD Card

Every Q24M Secure is delivered with a high-quality, factory-installed 4 GB MicroSD card (internal DVR) as a standard feature – sufficient for around 50,000 panorama images or 10 hours of HiRes continuous recording including audio (4 fps).

New, Waterproof Connections To The Camera

The network cable, MiniUSB and MxBus for IO extensions are easily connected over waterproof connectors with bayonet catch – without needing to open the camera housing – in the rear casing of the camera.

Adjustable PoE Classes, 1 to 3

The PoE class of the camera may be raised or lowered from the default value of 2 to 1 or 3 from the camera software, to precisely adjust the functionality of the camera, its accessories and the PoE switch.

New Audio Functionalities

Microphone and speakers are integrated and, thanks to the new HiFi audio component, the audio quality is once again improved and echoes during hands-free operation can now be suppressed. If data protection requires it, microphone and audio recording can be irreversibly switched off by securing the hardware.

Camera vPTZ functions may be controlled with a mouse or joystick

Using a joystick: Internet Explorer with activated MxPEG ActiveX plug-in, MxControlCenter or MxEasy required

MxControlCenter and MxEasy can be downloaded free-of-charge at www.mobotix.com

1.3 General MOBOTIX Camera Functions

Like all other MOBOTIX cameras, the Q24M models include a range of (software) functions, such as video motion detection, long-term recording, alarm messaging and video IP telephony, to name but a few. Unlike in camera systems from other manufacturers, buying and installing additional software on the computer is unnecessary. Instead of using a web browser, you can also download the free MxControlCenter software from the MOBOTIX website, which allows quick displaying of multiple cameras on one monitor, alarm switching with audio or an easy event search.

vPTZ: Virtual Pan/Tilt/Zoom Features

While MxControlCenter has provided virtual PTZ features for some time now, these features are now available directly via MOBOTIX camera. This means that you can continuously zoom into or out of the live image using either the mouse wheel or a joystick. When storing images or video sequences, you can choose to store either the visible image area of the live image or the full sensor image (full image storage). This also allows you to examine parts of an image or video that had not been visible in the live image section on display at the time of the recording.

Automatic Image Correction

Another problem familiar from the field of photography are the distortions that result from using wide-angle lenses. Straight lines near the image borders are bent outwards. The integrated distortion correction features of the camera (and of MxControlCenter) allow correcting the curve of various lenses using software algorithms.

HiRes Live Video With Up To 30 fps, Including Audio

MOBOTIX cameras deliver smooth live video with lip-synchronous audio, yet they keep network load to a minimum. Some analog systems may also be able to do this, but the recording quality is much higher with MOBOTIX since the cameras efficiently store the high, live image resolution and frame rate without compromising image quality. MOBOTIX technology thus provides for continuous recording of simultaneous video from 30 cameras at 30 frames per second each, including audio, all on one standard PC.

Low Bandwidth Requirements

MOBOTIX' patent pending **MOBOTIX streaming format MxPEG** allows fast live video with audio at extremely low network load (1 to 2 Mbps), even for high-resolution images. Since the MOBOTIX camera itself detects movements in the image (and not the computer), video sequences are only transmitted if movements occur.

Voice Over IP

Moreover, MxPEG provides for lip-synchronous live audio and two-way communication between the camera and a computer. Room surveillance is possible using a browser (Internet Explorer), MxControlCenter or MxEasy. Customized alarm notification on your

mobile or via Internet telephony is just as easy as event-controlled voice messages directly from the camera.

Internet Telephony (SIP) And Video SIP

Video SIP allows establishing audio/video connections to the camera using Windows Messenger or similar applications (e.g. CounterPath X-Lite/Eyeball). This feature also allows the camera to be remote controlled using the phone keys, the camera itself can place phone calls in case of alarms.

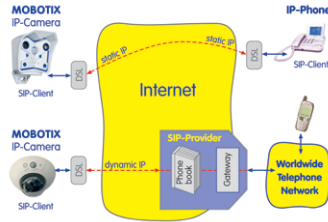

Long-Term Storage On File Servers Included

MOBOTIX cameras have an integrated long-term storage system for Linux, Windows and Mac OS X computers. Every camera manages its own ring buffer storage on the shared folder. Thanks to this decentralized approach, 30 live cameras can store images of up to 30 frames per second each, including audio, on a single computer.

Internal DVR: Storage on MicroSD Or CF Cards

MOBOTIX cameras support direct storage on an internal MicroSD/SD/CF card (basic models excluded). By using this integrated flash card DVR, the camera is able to offer the following additional applications:

- Stand-alone use of the camera without a file server by recording to the MicroSD card.
- High-security application with recording on a file server or NAS/SAN in which the SD card serves as storage buffer. It can thus bridge longer network or file server failures without losing any video sequences (supported in a future software version).
- Event downloads from the MicroSD card for evaluation of the recorded sequences on a computer.

	Internal DVR	External USB Storage	Remarks for USB Storage
M12	optional	optional	Adapter cable required
D12	optional	optional	Adapter cable required
V12	optional	-	-
M22M	optional	optional	Device can be connected directly
D24M	included	optional	Adapter cable required
Q24M	included	optional	Adapter cable required

Internal DVR is either an option during order placement (e.g. M12 R8) or upgradeable later with an SD card

D24M/Q24M Secure: 4 GB MicroSD card included

Event And Time-Controlled

Just like triggering event-controlled recording upon detecting movements in the image, the camera can also record when the volume detected by the microphone exceeds a certain trigger value. Using scheduled daily recording, time tasks can start or stop video

recording, upload images to a web site or send e-mails with video/audio clips. Vacation times and holidays can be programmed.

Remote Alerting

In case of an alarm, MOBOTIX cameras automatically pop up windows or activate other functions at a remote security control center. The cameras can use network/wireless, GSM/GPRS/UMTS (3G) or Internet connections for this purpose.

Integrated Power-over-Ethernet

Power is supplied as Power over Ethernet via the network cabling using the MOBOTIX NPA-PoE-Set or from a PoE compatible switch (both according to the IEEE 802.3af PoE Standard).

No heating required
- PoE is no problem
even in winter

Caution

Previous MOBOTIX network power accessories such as the NPA Set, Power Box and Power Rack (MX-NPA-Set, MX-NPR-4 and MX-NPR8/20) are not suitable for use with the Q24M.

No heating is necessary thanks to the well-insulated plastic housing and anti-fogging properties. Due to their low power consumption (approx. 3 watts), MOBOTIX cameras, unlike those of other manufacturers, may be operated both indoors and outdoors using a PoE power supply.

Logos, Animated Or Freestyle

The MOBOTIX camera logo generator allows time-scheduled banners and graphics (including files loaded automatically from any URL) to be integrated into current camera. MOBOTIX cameras are the only network IP cameras supporting animated and transparent graphics.

Logo generator for
display of graphics
already integrated
in the live image



30 Cameras Live Using MxControlCenter

Instead of using a web browser, you can also download the free-of-charge MxControlCenter from www.mobotix.com, which allows fast display of up to 30 MOBOTIX cameras on one monitor. In addition, MxControlCenter can process incoming alarms with sound from the cameras and allows comfortable search and evaluation of alarm video clips (including audio). The integrated Layout Editor of MxControlCenter allows you to quickly create floor plans by simply dragging/dropping the cameras onto a background image. Load a floor plan as background image, drag & drop the cameras; done.



Free download at www.mobotix.com

MxEasy – Intuitive Application For Windows, Macintosh And Linux

The new MOBOTIX MxEasy aims at easy operation of the most important camera functions through its intuitive user interface, thus creating a new user experience when viewing and controlling MOBOTIX cameras. The clear design allows management of up to 16 cameras, and the application can show up to four cameras at the same time.



Free download at www.mobotix.com

All settings selected in MxEasy (e.g. virtual camera position, zoom, brightness, volume, microphone sensitivity, image storage, signal outputs) are usable immediately and are stored instantly in the configuration of the corresponding camera. The calendar function integrated in the **Alarm Planner** provides access to innovative features for scheduled settings of one or more cameras.

For the first time, this tool not only controls video and audio recording based on certain time and date information, but also allows activating/deactivating features like video motion detection, image brightness and the microphone based on a date and time schedule.

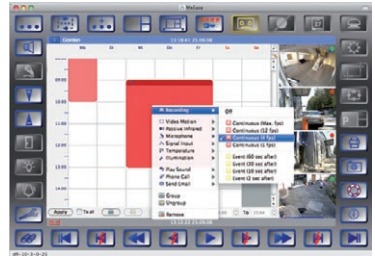

MxEasy is available as a free-of-charge download for MS Windows and Mac OS X operating systems under www.mobotix.com. A Linux version will be available soon.

Diverse Installation Options

Not only can MOBOTIX cameras be installed under almost all weather and temperature conditions, they also offer suitable installation materials from a wide range of accessories for any conceivable application scenario.

Additional Camera Functions (Software)

- **True software scaling** to easily generate smaller image formats for PDAs (such as 320x240, 160x120, etc.).
- **Audio video recording** with three different recording modes: event recording with audio, continuous recording with variable frame rate and audio as well as event-controlled snapshot recording of JPEG images.
- **Storage failure detection** can monitor a file server (or a flash device) and can use one or more of the defined messaging options for error notification.
- **Player of recorded images/video sequences with audio** in the integrated video management system.
- **Multivatcher screen can display and monitor several cameras** over the Internet, with only one camera requiring access from the outside. This "proxy" camera uses only very little bandwidth, making it an ideal solution for low-bandwidth connections.
- **MultiView screen for displaying multiple cameras** or events in one browser window.
- **Event notification** by e-mail, SMS (using a provider), voice notification (Phone Call-Out), sounds and by visual means (e.g. red frame in live image) using two separate messaging paths.
- **Object tracing** for analyzing the paths of objects that are moving in the image.

- **Time Tables** with handling of customized holidays and vacations. The time tables are used to control the camera's arming, image recording messaging, logos, the obscure image function as well as other features.
- **Remote signaling for master/slave cameras**, with the master camera controlling the arming status of the slave cameras. This allows arming, for example, of all slave cameras using a key switch connected to the master camera.
- **Transfer profiles** for comfortably controlling transmissions via FTP, e-mail, phone calls and network messages.
- **Speakerphone*** with speak, listen and intercom modes using the microphone and speaker.
- **Phone Call-In* to remotely control the camera using a touchtone telephone** (retrieve camera information, establish an Internet connection, announce the retrieved IP address, intercom feature, etc.).
- **MxPEG video compression** using MxControlCenter. The ActiveX plug-in for Internet Explorer users brings all advantages of MxPEG to the browser-based user interface (including the audio stream to and from the camera).
- **Routing** allows use of other network connections besides the standard route.
- **DynDNS client** for accessing the camera via the Web using a symbolic name (e.g. mymobotixcam.dyndns.org), despite the provider assigning a new dynamic IP address every time the camera connects to the Internet.
- **None-voidable backup system** starts the cameras in the original operating state if a software update fails, allowing the user to easily restart the update process.
- **Enhanced startup options** for the camera (obtain IP address via DHCP, announcement of IP address and other network data, reset to factory default settings).
- **Notifications upon errors or when rebooting** provide a method for executing one or more notifications (e.g. blinking of the camera LEDs, audio message, FTP, e-mail, phone call, network message).
- **Extended security features** protect the pages and features of the camera and prohibit unauthorized access (IP-level access control, intrusion detection). They also provide SSL-protected transmission of the video sequences and the data (using SSL encryption and X.509 certificates).

* Telephony features using VoIP connections (internet telephony)

Free Software Updates (www.mobotix.com)



MOBOTIX provides **software updates free-of-charge** at regular intervals that improve and expand the camera's functionalities. Chapter 6, *Software Update*, in the *Software Manual* provides more information on the process.

Free-of-charge software updates from www.mobotix.com

1.4 Lens Options, Hardware And Software Features

MOBOTIX Q24M cameras come with a standard **L11 fisheye lens with a 180° horizontal image angle**. The camera is also available with an **L22 Super Wide-Angle lens with a horizontal image angle of 90°**. The integrated virtual PTZ features of the camera software or MxControlCenter/MxEasy properly correct the lens distortion that is specific to each of the lenses. Both lenses deliver good image quality even when using maximum digital zoom. Since MOBOTIX cameras are backlight-proof, they do not require a mechanical auto iris, making them extremely robust and maintenance free.

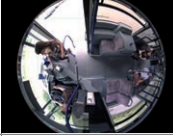

Lens Table	L11	L22
Original image		
35mm equivalent focal length	11 mm (0.43 in)	22 mm (0.87 in)
Actual focal length	1,8 mm (0.07 in)	4 mm (0.16 in)
Aperture	2.0	2.0
Horizontal image angle	180°	90°
Vertical image angle	160°	67°
Distance 1 m (1.09 yd):	m	m
Image width	infinite	2.0
Image height	11	1.3
Distance 3 m (3.28 yd):	m	m
Image width	infinite	10.0
Image height	55	6.6
Distance 10 m (10.94 yd):	m	m
Image width	infinite	20.0
Image height	110	13.3
Distance 20 m (21.88 yd):	m	m
Image width	infinite	40.0
Image height	220	26.6

Notes

The specified focal lengths of MOBOTIX lenses do not reflect the actual focal length of the lenses, but the focal length (Lxx mm) converted to 35 mm camera format. For example, the MOBOTIX Super Wide-Angle lens has an actual focal length of 4 mm. This would be the equivalent of 22 mm on a 35 mm camera. This lens is thus called L22.

Converting the focal lengths to 35 mm camera as a known format provides for better comparison of the image formats and the image angles of the different lenses. Another benefit is that you can easily set any average 35 mm camera (analog or digital) to the same focal length as the MOBOTIX lens (Lxx) to obtain the same image angle. This approach greatly facilitates lens selection.

Stated focal lengths of MOBOTIX cameras are given with reference to a 35 mm camera

	Q24Mi-Basic D11 /MX-Q24Mi-Basic-D11	Q24Mi-Basic D22 /MX-Q24Mi-Basic-D22	Q24M-Secure D11 /MX-Q24M-Sec-D11	Q24M-Secure D22 /MX-Q24M-Sec-D22
---	---	---	--	--

Q24M Hardware Features

Outdoor weatherproof	IP54	IP54	IP65	IP65
Ethernet/ISDN/USB/RS232	E /- / - /-	E /- / - /-	E /- / U*/-	E /- / U*/-
MicroSD slots	-	-	1	1
Integrated microphone/speaker	-/X	-/X	X/X	X/X
Mono (M) / Dual (D)	M	M	M	M
Image Sensor	Color	Color	Color	Color
Lens	L11	L22	L11	L22
Resolution	VGA	VGA	3 MEGA	3 MEGA
Resolution horizontal x vertical	640x480	640x480	2048x1536	2048x1536
Max. frame rate CIF/VGA/MEGA/3MEGA (fps)	16/16/-/-	16/16/-/-	30/30/30/20	30/30/30/20
Sensitivity at 1/60 second (lux)	1	1	1	1
Sensitivity at 1 second (lux)	0.05	0.05	0.05	0.05
RAM Storage (MB)	64	64	128	128
Temp. video storage, ring buffer (MB)	2	2	64	64
Internal DVR (MicroSD card), ring buffer (GB)**	-	-	up to 32	up to 32
• CIF images (for 32 GB int. DVR), approx.	-	-	2 mil.	2 mil.
• VGA images (for 32 GB int. DVR), approx.	-	-	1 mil.	1 mil.
• MEGA images (for 32 GB int. DVR), approx.	-	-	350,000	350,000
• 3 MEGA images (for 32 GB int. DVR), approx.	-	-	160,000	160,000
External audio (Line-In/Out)	-	-	-	-
Signal input pins	-	-	-	-
Signal outputs	-	-	-	-
Concealed cabling	X	X	X	X

Q24M Software Features

Digital zoom (continuous) with panning	X	-	X	X
Panorama and surround views	X	-	X	-
Additional storable views	X	-	X	X
Full image recording	-	-	X	X

*Special MiniUSB adaptor cable available as an accessory

**A 4 GB MicroSD card is included with all Q24M Secure models, MicroSD cards of up to 32 GB may be used (SDHC)



Software Features (All Models)

	Basic Model	Web Model	IT Model	Secure Model
Digital zoom (continuous) with panning	X*	X	X	X
Motion JPEG/MxPEG video streaming	X/X	X/X	X/X	X/X
Custom exposure windows	X	X	X	X
Video Motion detection	X	X	X	X
Time and event control (FTP, email, logos)	X	X	X	X
Weekly schedules/holidays	-	X	X	X
Web functionality (FTP, email)	X	X	X	X
Quad/MultiView in browser	X	X	X	X
Recording/Playback in browser	X	X	X	X
Logo generator, animated	-	X	X	X
Single image recording (pre-/post-alarm images)	3	3	10	50
Terabyte ring buffer (Win/Lin/Mac) via network	-	-	X	X
Continuous video/audio recording, 0.2 to 30 fps	-	-	X	X
Video/audio recording (event-triggered)	-	-	X	X
Event-controlled frame rate with continuous audio	-	-	X	X
Flexible event logic	-	-	-	X
Master/Slave arming by one camera	-	-	-	X
Time-scheduled privacy zones, several areas	-	-	-	X
Bidirectional audio (IP) from/to browser	-	-	X**	X**
Customized voice messages	-	-	X	X
VoIP telephony (Audio/Video, SIP)	-	-	X**	X**
Alarm calls to softphones (SIP) e.g. X-Lite	-	-	X	X
Remote alarm notification (via TCP/IP, IP Notify)	-	-	X	X
RS232 Data Logger/Terminal	-	-	X***	X***
Programming interface/HTTP API	-	-	X	X
Security features (HTTPS/SSL, IP-level access control, network authentication IEEE 802.1X)	X	X	X	X

Model Feature List

Image size	VGA	3 Mega	VGA	3 Mega
Image Sensor	Color	Color	Color & B/W	Color & B/W
Standard lens for software version	L22	L22	L22	L22
Audio support (Microphone/Speaker)	-/L**	-/L**	M/L**	M/L**

The Web version is only available for the M12

The Basic version is only available for the D22M and Q24M

The IT version is not available for the Q24M

*Only available for Q24M

**D22M IT and Secure models allow connecting an external speaker and microphone. D22M cameras are not delivered with a microphone and speaker

***RS232 only for M12/D12

SW image sensors with megapixel resolution (1280x960 pixels)

M12 lens included if requested by customer

2 INSTALLATION

The Q24M is primarily designed for installation on walls or ceilings. The supplied L11 180° lens captures the entire room, practically from wall to wall and from floor to the ceiling. See sections 2.4 and above. for the different installation options; drilling templates can be found at the end of the manual.

2.1 Preparing The Installation

Before mounting the MOBOTIX Q24M, the following questions should be answered:

1. **Where will the camera be mounted?**
Mounting to a ceiling or wall; section 2.1.1. and 2.1.2
2. **Which other mounting options are available?**
On-wall mounting, in-ceiling mounting, vandalism protection, wall mounting, pole mounting, see section 2.1.3
3. **How is the camera connected to network and how is power supplied?**
MX-NPA-PoE or other PoE components (IEEE 802.3af), see section 2.1.4
4. **How are the connections furnished from the building?**
Wall outlets, see section 2.1.5
5. **What cabling considerations are necessary?**
Wiring, see section 2.1.6 and 2.11

The following sections contain a brief answer to each of these questions, as well as references to the relevant sections in this manual. For more information on the MOBOTIX Q24M and available accessories, please see: www.mobotix.com

Wall installation with
On-Wall Set 10°



2.1.1 Wall-Mounted

To make optimal use of the high-resolution 180° panorama functionality of the Q24M, the camera must be mounted on an internal or external wall. The entire hemisphere of the room directly in front of the camera is then effectively monitored, from the wall on the left of the camera to the wall on the right. Corresponding fine-tuning in the user interface software allows the displayed panorama image to be adjusted to different practical applications (see section 3.3).



Wall installation with On-Wall Set 10°

The camera should preferably be mounted in the middle of the room to be monitored using the 10° On-Wall Set

The Q24M Panorama: one camera - three simultaneous views

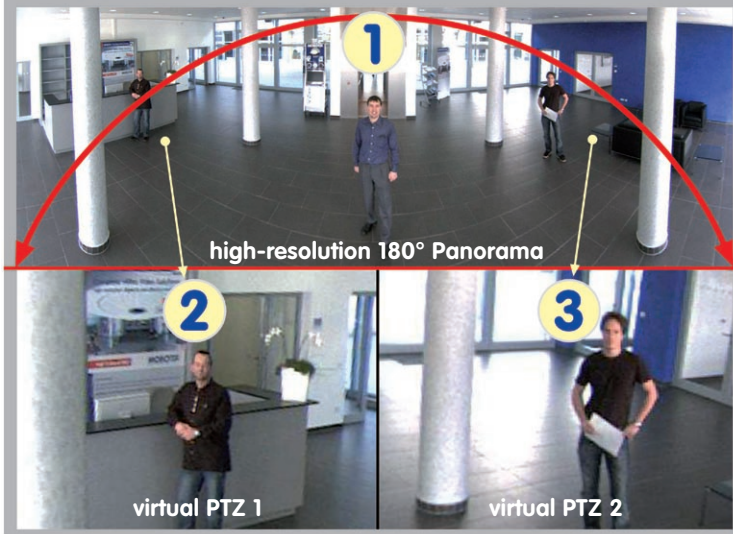

Original image from the camera shown above using the 10° On-Wall Set (Panorama Focus View)

Selecting An Appropriate Camera Position

The Q24M is primarily suited to providing an excellent overview, and less suitable for more exact details. For active operation, the camera should be mounted at a (out of direct reach) height ranging from 2.5 to 3.5 m. People, for example, may be identified very well at distances of up to 1.5 m, and with sufficient detail at up to 3 m. Objects can be recognized even at distances of 5 m and more from the camera. During installation, ensure that the camera is focused on the most important areas of the room as directly as possible, in order to provide the desired level of detail recognition. For wall installation, use of the 10° On-Wall Set is ideal in many cases.

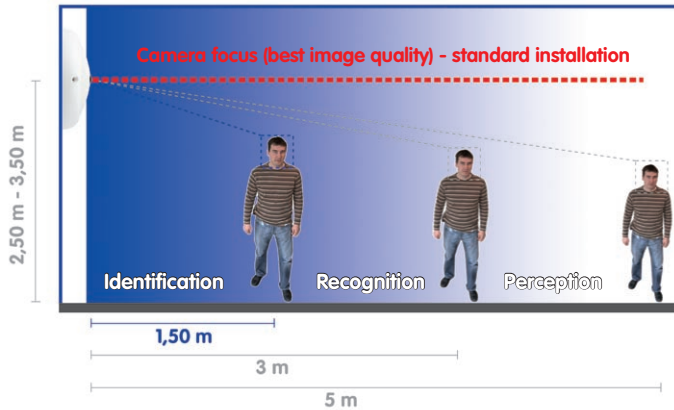

Recommendation:
Mounting the camera in
the middle of the wall



The OBEN / TOP label
is only visible when the
outer shell is removed

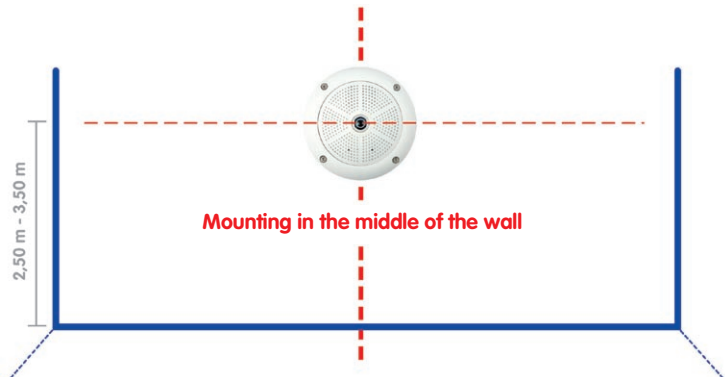

Hint: The Q24M should always be installed on a wall such that the arrow on the camera housing marked OBEN / TOP points towards the ceiling of the room.

Wall Installation With The 10° On-Wall Set For Image Optimization

An on-wall set, available as an accessory in 0° and 10° inclinations, may also be used for installation. While the 0° set primarily offers easier installation and more storage space for cables and add-on modules (WLAN, connectors, etc.), the 10° set may also increase the image quality in certain cases. In particular for wall installations which must be carried out at greater heights for technical or other reasons (over doors, windows, etc.) adding a slight tilt to the camera, and thus also the lens, will return better results, as the center of the lens is then focused more directly on the center of activity in the room (optimal utilization of lens capabilities).

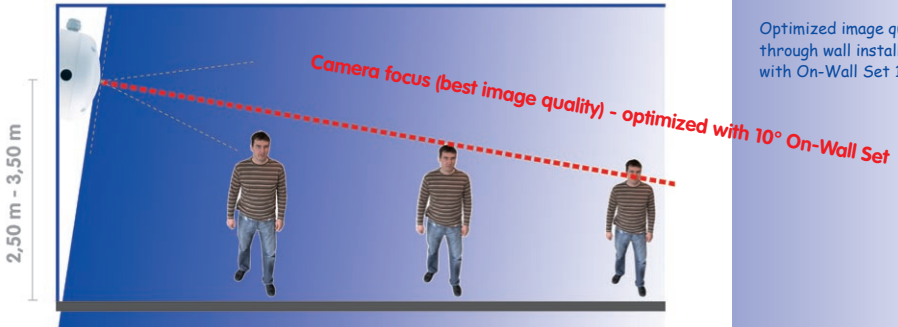

Optimized image quality through wall installation with On-Wall Set 10°

Wall Mounting Over A Wall Outlet

Professional wall or ceiling installation of a Q24M is generally possible without accessories. However, due to elevation of the rear casing of the camera caused by connections and holders, a wall outlet should be installed prior to camera installation (see drilling template Q24M). This provides perfect protection to the cabling, ensuring that it cannot be seen or damaged from outside.

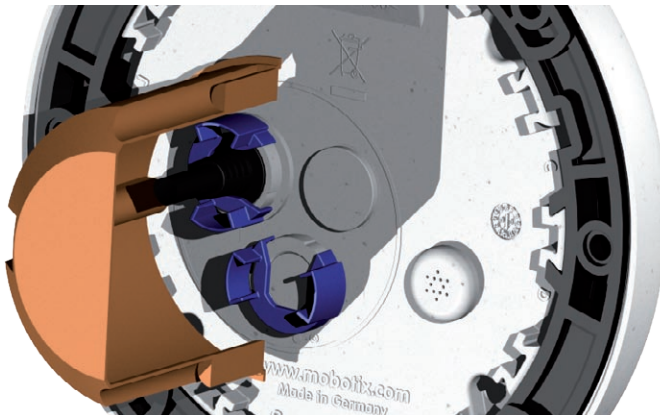

Discreet ceiling
installation using the
In-Ceiling Set

2.1.2 Ceiling-Mounted



Thanks to its hemispherical lens, a single Q24M can monitor an entire room right into each of the four corners (360° Panorama View). The camera's should ideally be positioned on the ceiling in the center of the room. Due to its inherent physical and optical properties, the precision of the lens decreases as the distance from the lens grows. This means that the maximum usable image area varies greatly depending on the intended purpose of the camera. Rooms with a square floor area of up to approx. 40 m² in general allow recognizing details even at the borders of the full image. If you would only like to know if persons enter a room, or to monitor specific objects, rooms of up to 100 m² floor area can be monitored using a single Q24M.

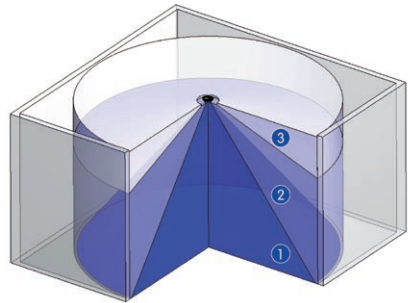

The **image quality** (precision) diminishes as the distance of an object to the camera focus point increases: 1 very good, 2 good, 3 satisfactory

Outdoors, the Q24M is usually mounted on a building wall, corner or pole instead of the ceiling. **For this situation, we recommend the use of the practical wall mount from the range of accessory products (section 2.8) or an extension.**

Non-Square Rooms

When viewing a 360° (full) image in the browser, you will notice that the top and bottom of the image is not fully visible, i.e. some image information has been clipped. This is not a fault of the camera, but intended behavior that aims at achieving the best possible utilization of the image sensor by the camera software. Bearing this in mind, it is advisable to install the Q24M in rectangular room ceilings so that the arrow marked OBEN / TOP points towards one of the longer walls of the room as shown in the figure.

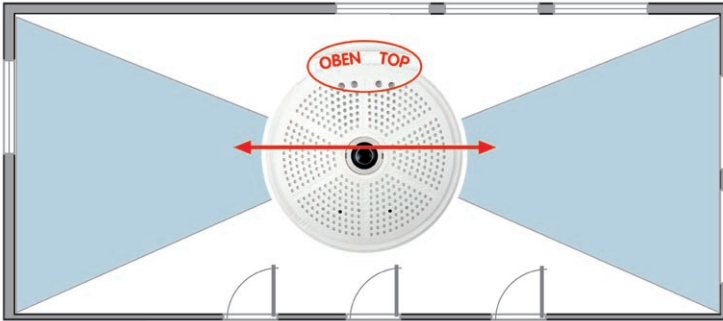

Original full image from the Q24M (ceiling installation in a rectangular room)

The camera should not be directly mounted to metal surfaces (condensation may damage the camera): in such cases, **MOBOTIX** recommends using the On-Wall Set or Wall Mount

Wall Mount
(MX-OPT-WH)



On-Wall Set
(MX-OPT-AP)



Installation requires a Corner and Pole Mount, as well as a Wall Mount

Wall Mount
(MX-OPT-AP)



Lowered Mounting Or Mounting on Extensions

When mounting the camera in rooms with a high ceiling, or outdoors, it is sometimes advisable to mount the camera in a lower position. This reduces the distance between the camera and the objects that are to be monitored, which in turn increases the recognizability of details. One practical solution would be to install the camera on a base plate attached to a suitable extension (e.g. tube) hanging from the ceiling. The network cable can be hidden from view by running through the interior of the tube.

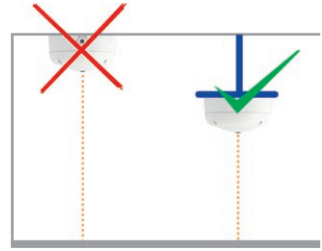

Similar to lowered mounting from the ceiling, you can also attach the camera to an extension mounted to a wall to better use the 360° image of the camera (e.g. outside, above a portal). Such an installation would use the wall mount accessory (MX-OPT-WH).

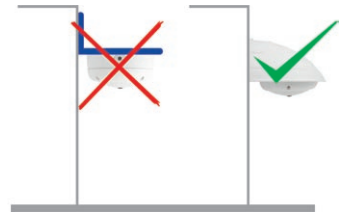

MOBOTIX does not recommend attaching the camera directly to metal carriers, especially when mounting the camera outdoors or when the ambient temperature varies greatly. To protect against condensation in such a case, you should attach the camera to the carrier using only the On-Wall set (MX-OPT-AP) or the Wall Mount (MX-OPT-WH).

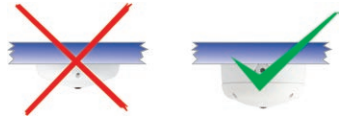

Installation On Building Corners With The Corner And Pole Mount

This is a special method of Q24M installation, offering substantial advantages for the outdoor surveillance of buildings.

The hemispherical lens of a single Q24M can cover the entire 270° range from one building wall to the other, for an "around the corner" view!

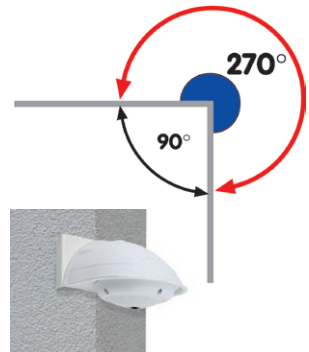

2.1.3 Mounting Options

On-Wall Installation (MX-OPT-AP)

The On-Wall Set can reliably protect external cables if the cables cannot be fed in the center below the camera housing. The On-Wall mount also provides ample space for extra modules.



On-Wall Set (IP65, for outdoor applications)

On-Wall Installation With 10° Inclination (MX-OPT-AP-10DEG)

This On-Wall Set is identical to the regular On-Wall Set, except that the mounted camera is tilted by 10 degrees. The inclination makes it possible for the camera to deliver the best images even in demanding situations.



On-Wall Set 10° (IP65, for outdoor applications)

In-Ceiling Installation (MX-OPT-IC)

The In-Ceiling Set allows the Q24M camera to be installed in suspended ceilings, for example. This type of installation provides optimum protection for the camera and reduces the visible profile to a minimum, since the camera only protrudes 24 mm from the ceiling.



Discreet in-ceiling installation; decorative outer ring also available in stainless steel

Vandalism Set (MX-Q24M-OPT-VANDAL)

The Vandalism Set provides added protection for Q24M cameras. The set consists of a robust stainless steel cover (matt or polished) and an impact-resistant polycarbonate dome. A camera equipped with the Vandalism Set is perfectly suited for applications in demanding environments (such as prisons, trouble areas, train stations, etc.).



Vandalism Set (IP65)

Wall Mount (MX-OPT-WH)

The Q24M/D22M Wall Mount is the ideal solution for mounting the Q24M to walls for indoor and outdoor applications. The camera is absolutely dustproof and resistant against water jets (IP65). The wall mount also covers RJ45 wall outlets and has ample space for additional modules.



Wall Mount made from sturdy PBT-30GF (IP65)

Corner And Pole Mount (MX-OPT-MH)

The MOBOTIX Corner and Pole Mount is the ideal choice when mounting the MOBOTIX Q24M to a pole or building corner (Panorama View covering approx 270°). This mount can only be used in conjunction with the wall mount. For poles with a diameter ranging from 60 to 180 mm.



Outdoor Corner and Pole Mount made from stainless steel (in conjunction with Wall Mount)

The Q24M supports the Power over Ethernet standard IEEE 802.3af (PoE)

The Network Power Adapter replaces the crossover cable when directly connecting to a computer

For the Q24M, you should use the new blue MX-NPA-PoE Set - previous MOBOTIX network power accessories such as the NPA Set, Power Box and Power Rack (MX-NPA-Set, MX-NPR-4 and MX-NPR8/20) are not suitable for use with the Q24M



2.1.4 Network Connection And Power Supply, UPS

Power over Ethernet (PoE Conforming To IEEE 802.3af)

All Q24M models are supplied with power using the PoE standard. The Network Power Adapter (MX-NPA-PoE-Set) may be used for smaller installations. For larger installations, it is worth investing in a PoE capable supply device available on the market.

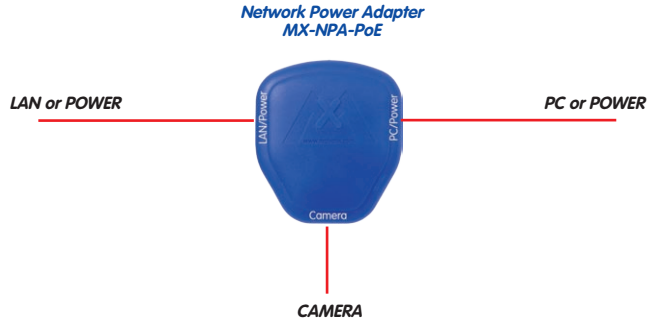

Caution

The **maximum length** of the network cable for power supply over an Ethernet cable is **100 m**. Previous MOBOTIX network power accessories such as the NPA Set, Power Box and Power Rack (MX-NPA-Set, MX-NPR-4 and MX-NPR8/20) are not suitable for use with the Q24M.

Note

The MOBOTIX Q24M can be powered by switches or routers which support the PoE (Power-over-Ethernet) standard and conform to IEEE 802.3af.

Sections 2.11 and above contain more information on the possible combinations of connecting the Q24M and power supply options.

Advantages of PoE power supply:

- Advantages of centralized backup power supply are available via network
- Lower, more cost-efficient power consumption
- Camera does not require an additional network connection

Using Uninterruptible Power Supplies (UPS)

In order to maintain a continuous power supply even when utility power fails, you should install an uninterruptible power supply (UPS). These devices also provide full protection against electrical surges and voltage fluctuations and thus enhance the reliability of the system as a whole.

When using a more powerful 19" rack-mounted UPS, you can also protect all other network components (e.g. switches, routers, PoE switches, etc.).

Since MOBOTIX cameras do not require any heating (even during winter), the average power consumption of approximately 3 watts is very low. This in turn means that you can centralize the UPS-protected power supply by injecting power into the network cables (max. 100 m). This kind of protected power supply can be used either with MOBOTIX PoE products (MX-NPA-PoE + Universal Power Supply) or with PoE-compliant switches according to IEEE 802.3af.

UPS not only protect the camera against power failures, they also protect all other connected network devices against damage from voltage peaks and lows

19" system with UPS

Camera power supply using PoE enables centralized UPS via network (increased security)

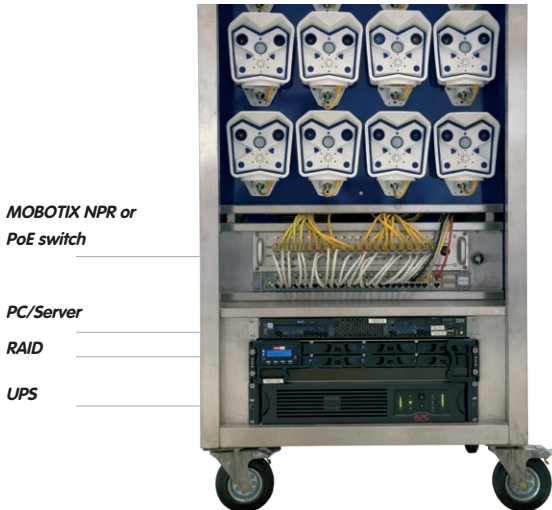

*MOBOTIX NPR or
PoE switch*

PC/Server

RAID

UPS

2.1.5 Preparing The Camera Connections, Wall Outlets

Once the camera position, the position of the cable outlets and the method of power supply have been decided upon, the cabling can be installed. Before mounting the MOBOTIX Q24M, you should make sure that the network connections have been properly tested to ensure that the camera functions correctly when it is installed.

2.1.6 Wiring, Fire Prevention, Lightning And Surge Protection

When installing the wiring inside or outside of buildings, make sure you always adhere to the relevant regulations on wiring, fire prevention and protection against lightning.:

MOBOTIX cameras are protected against the effects of small electrical surges by a range of measures. These measures, however, cannot prevent the camera from being damaged when stronger electrical surges occur. Particular care should be taken when installing the camera outside to ensure proper protection against lightning, as this also protects the building and the entire network infrastructure.

MOBOTIX recommends having MOBOTIX cameras installed only by certified specialists accustomed to installing network devices and having proper respect for the applicable regulations regarding lightning protection and fire prevention as well as the current technology for preventing damages from electrical surges.

Wiring

When installing the wiring, make sure to follow these guidelines:

- Data cable: Make sure you only use double-shielded CAT5 or higher cable (S/STP) for Ethernet connections.
- Outdoors: Installing the camera outdoors requires special precautions and measures regarding the cables as well as lightning and surge protection (see below).
- Wire lengths: The cable segments must not exceed the maximum allowed cable lengths in order to ensure proper data transfer (see section 2.11).
- Avoiding induction: When running data cables parallel to existing regular power lines or high-voltage wires, make sure you observe the minimum distances to the power cables.



Fire Prevention

When installing the power lines to the camera, make sure you always adhere to the country-specific regulations (e.g. VDE in Germany, IEEE in the USA) in effect on wiring and fire prevention at the site of the installation.

Lightning And Surge Protection

More information is available at an institution such as the International Electrotechnical Commission (IEC, www.iec.ch) or at a manufacturer of protection devices against lightning and electrical surges, such as Dehn (www.dehn.de).

2.2 Q24M Basic/Secure: Delivered Parts, Components, Dimensions

2.2.1 Delivered Parts And Camera Components



Item	Quantity	Part Name
1.1	1	Camera
1.2	1	Lens (included)
1.3	1	Lens wrench
1.4	1	MicroSD card (4 GB)*, pre-installed
1.5	1	CAT5 patch cable, 0.5 m incl. washer, pre-installed
1.6	1	Allen wrench 3 mm
1.7	1	Allen wrench 2 mm
1.8	1	Torx wrench
1.9	1	Outer shell
1.10	1	Mounting ring
1.11	4	Universal screw anchors 8 mm
1.12	4	Stainless steel washers Ø 5,3 mm
1.13	4	Stainless steel wood screws with hex head 4.5x60 mm
1.14	4	Stainless steel Allen screws M4x16 mm
1.15	4	Stainless steel washers Ø 4.3 mm
1.16	2	Cable retainer with bayonet catch (patch cable, MiniUSB)

*MicroSD card only available for Q24M Secure

2.2.2 Camera Housing And Connectors

The MOBOTIX Q24M consists of the camera housing (motherboard and lens), the outer shell and the mounting ring.

Connections

- Network (Ethernet network incl. PoE power supply)
- MiniUSB (e.g. for ExtIO)
- Slot for MicroSD card



Slot for MicroSD card
(not externally accessible)

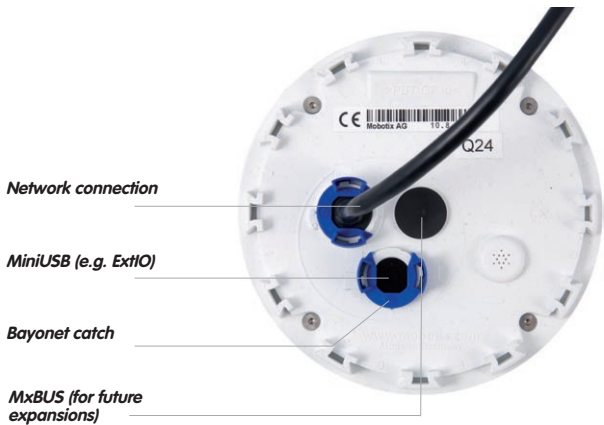

2.2.3 Q24M: Dimensions Without Mounting Options

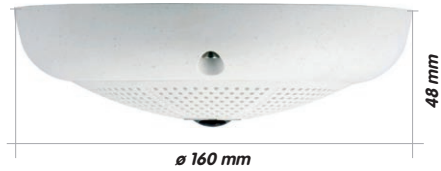

Mounting Ring Drilling Template (Incl. Space For Wall Outlet)

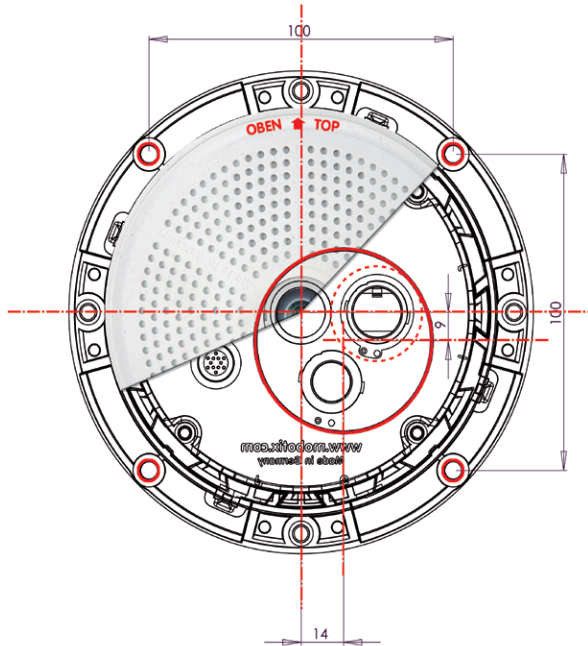

Find the drilling templates (scale 1:1) at the end of the manual as a fold-out

The red circle indicates the hole to cut for the wall outlet

Note

Find the folded drilling template at the end of the manual.

Make sure that the drilling template is not scaled or adjusted to the paper size when printing the PDF file (enlarged or reduced).

2.3 Available Q24M Accessories - Overview

On-Wall Set (MX-OPT-AP)

Consists of On-Wall Mount and mounting supplies. Conforms to U.S. installation standards. Reliably protects the cabling and allows integrating additional modules within the On-Wall Mount (patch cable/installation cable connector, IO extensions, WLAN, battery, ...).



10° On-Wall Set (MX-OPT-AP-10DEG)

Consists of On-Wall mount and mounting supplies for inclined installation (10°) of a camera. Conforms to U.S. installation standards. Reliably protects the cabling and allows integrating additional modules within the On-Wall Mount (patch cable/installation cable connector, IO extensions, WLAN, battery, ...).



Vandalism Set (MX-Q24-Sec-Vandal-ESPO)

Consists of polished stainless steel housing, lens protector and security screws. Ideally suited for surveillance at critical locations.



ø 166 mm

Vandalism Set (MX-Q24-Sec-Vandal-ESMA)

Alternative design featuring matt stainless steel housing. As above incl. lens protector and security screws.



ø 166 mm

The polished stainless steel housing has a thickness of 1.5 mm

The matt stainless steel housing has a thickness of 1.5 mm

In-Ceiling Set (MX-OPT-IC)

For simple installation in false ceiling tiles. Suitable for discreet surveillance. Optionally available with a stainless steel ring.



Also suitable for mounting to drywall

Outdoor Wall Mount (MX-OPT-WH)

Consists of Outdoor Wall Mount and mounting supplies. Covers RJ45 wall outlets. Space for expansion modules (battery, UMTS, WLAN, etc.) Easily mounted to poles using Pole Mount. Weatherproof IP65.



Corner And Pole Mount (MX-OPT-MH)

Flange for Outdoor Wall Mount. Can be mounted to wall corners or poles. 3 mm stainless steel, white. Wall Mount may be ordered separately or as a set.



Network Power Adapter Set (MX-NPA-PoE-Set*)

The Network Power Adapter Set allows injecting the power supply for the MOBOTIX Q24M into the network cable. This makes it possible to use the network cable to both connect the camera and remotely supply power (up to 100 m). The MOBOTIX Network Power Adapter Set including power supply with RJ45 connector is required if you do not use a PoE compatible switch or router to supply power to the MOBOTIX camera.



* Country-specific versions of the set are available from MOBOTIX (DE, US, GB, AUS, JP)

ExtIO Function Extension (MX-ExtIO)

The ExtIO contains a powerful speaker, microphone, infra-red motion sensor, environmental temperature sensor, 2 input and 2 output contacts and 2 illuminated buttons. It is ideal for door communication, elevators, access control, etc.

The ExtIO may be operated directly with the Q24M over a separately available MOBOTIX USB cable. The ExtIO can operate in two different modes:

- MiniUSB: Directly connected to the camera using a separately available cable (max. 5 m)
- Ethernet: Connect the ExtIO over a standard PoE switch; maximum distance to camera 200 m

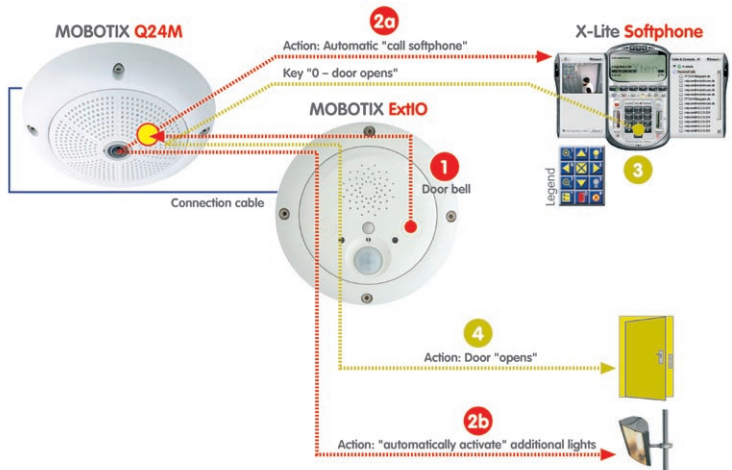

Mx2wire Media Converter (MX-2wire-Set-PW)

The Mx2wire system allows you to set up an Ethernet Network with PoE over paired telephone wires. This allows an existing two-core analog telephone line to be put to use to connect a 10/100 MB Ethernet device (e.g. PC, WLAN, network camera, IP telephone or IP door station). The achievable data rate is up to 40 Mbps. Around 15 Mbps can be reached over 500 m of bell wire.



An identical Mx2wire device is placed at the beginning and the end of the line. Configuration as sender or receiver is automatic. The Mx2wire nodes are supplied with power by the feeding network cable. The connected devices may be supplied with up to 8 watt over PoE, as the injected PoE signal is transmitted parallel to the network signal. The Mx2wire is delivered in a standard wall outlet frame available in different designs, but may also be used with the included on-wall outlet.

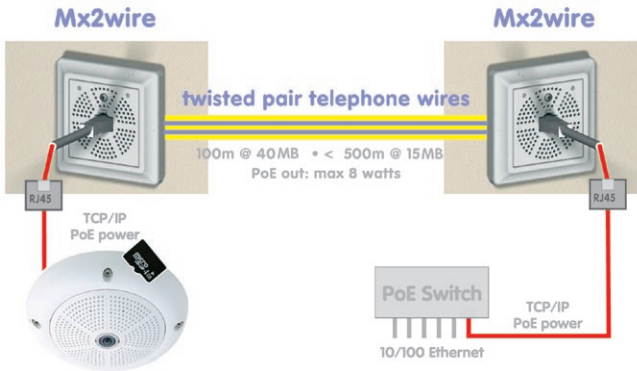

2.4 Mounting The Camera Without Accessories



2.4.1 Mounting Instructions

The Q24M, being an overview camera, is primarily designed for installation on walls or ceilings. Direct installation of the camera without any accessories is, in general, always possible, however - due to elevation of the rear casing of the camera where connections and their holders are - a flush-mounted wall outlet should be installed first.

Installation over a standard flush-mounted wall outlet (minimum installation depth 20 mm)

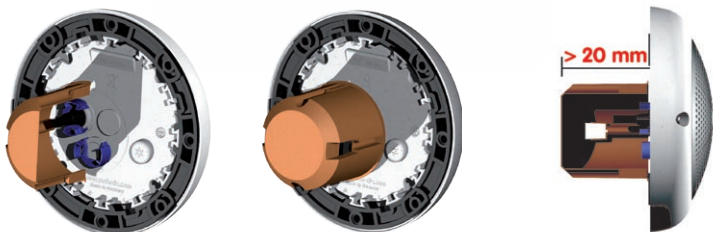

The drilling template also includes a blue circle marking the minimum size and position of this wall outlet, in addition to the drilling holes. To guarantee maximum coverage of the room by the camera, the Q24M should be positioned on the wall or ceiling as close to the middle of the room as possible.

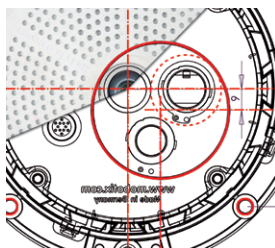

2.4.2 Required Tools

Please check that all components supplied with the camera are present in the original packaging first (see section 2.2).

The Following Additional Tools Are Required For Installation:

- Any additional materials for fastening the camera to a ceiling/wall, if necessary – **4 wood screws incl. screw anchors and washers** are included in the original packaging.
- **Screwdriver**
- **Power drill** for screw anchor holes needed for ceiling/wall mounting
- **MOBOTIX Drilling Templates** (at the end of this manual)
- **Scissors** to cut out the template
- **Pen** to mark the drill holes
- Materials and any tools needed to connect the pre-installed MOBOTIX network cable in the camera with the on-site network cable.
- **Wall outlet and tools** to install the outlet in the wall/ceiling (keyhole saw)
- **Soft cotton cloth** to clean the front of the lens



Q24M side view
incl. cable

Ideal cabling circumstances are provided if the corresponding hole depth (e.g. flush-mounted wall outlet) is at least 20 mm.

RJ45 patch cable: 50 cm (19.7 in) cable incl., other lengths available from MOBOTIX as accessories

Due to the space required for cable and connectors, we recommend a flush-mounted wall outlet with an installation depth of at least 20 mm

2.4.3 Procedure

1. Install and prepare the **network connection**.
2. **Install the flush-mounted wall outlet:** The pre-installed cable attached to the camera must be connected with the on-site network cable. For installation without accessories, a flush-mounted wall outlet must be installed first, in order to provide a connection. The cabling is perfectly protected and cannot be seen or damaged. The camera cannot be mounted directly on top of protruding wall outlets. Use the supplied camera drilling template (fold-out at the end of this manual) to mark the position of the wall outlet for the desired camera position.
3. **Remove the outer shell:** Remove all four Allen screws using the supplied Allen wrench and lift off the outer shell.
4. **Drill the holes:** Drill the holes for the supplied screw anchors (see drilling template). Remember to take the proper direction of the camera into consideration (OBEN / TOP arrow pointing upwards for wall installation, or in the direction of the longer wall for ceiling installation in rectangular rooms).
5. **Connect the cable:** Connect the on-site network cable to the camera patch cable using a standard connector.

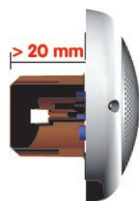
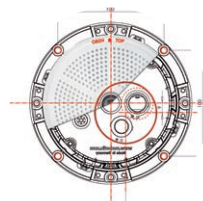

6. **Mount the camera:** Use the (included) screws to affix the mounting ring and the camera at the designated position.



7. **Install the rubber seal:** Place the rubber seal with the groove around the edge of the black mounting ring of the camera.



8. **Attach the outer shell:** Replace the outer shell and screw all four Allen screws tight using the supplied Allen wrench. Ensure that the rubber seal is properly positioned.



9. **Clean the lens:** If necessary, gently clean the front of the lens with a soft cotton cloth. Do not apply excessive pressure to the surface of the glass when cleaning the lens.
10. **Establish a connection to the camera, check the image:** Establish a connection to the camera as described in sections 3.1 ff. The live image from the camera should be visible on the computer monitor. Check image sections on the computer monitor as well.

Caution

The **maximum torque** for all screws is **1 to 1.2 Nm**.

Only use the factory pre-installed network cable supplied with the MOBOTIX camera. Always ensure that the cable retainer with bayonet catch is closed properly around the network cable. All openings at the back of the camera housing except the pressure equalization element need to be sealed properly with the rubber plugs. This is the only way to guarantee that the camera remains weatherproof.

Note

Note on fastening cables leading in to the camera:

Cables passing in to the back of the camera (patch cable for the network connection and ExtIO cable) are secured using a special cable retainer with bayonet catch.

When replacing this cable, ensure that the cable is properly seated in the connector and that the retainer with the blue bayonet catch is locked (short clockwise turn until it clicks into place).

**Removing The Cable Retainer**

Rotate the bayonet catch anti-clockwise to the "open circle" symbol (see diagram). The catch may be removed from the side. The cable can now be pulled out of the camera.

Open the cable retainer by rotating the bayonet catch to the marked position

Bayonet catch open



Bayonet catch closed

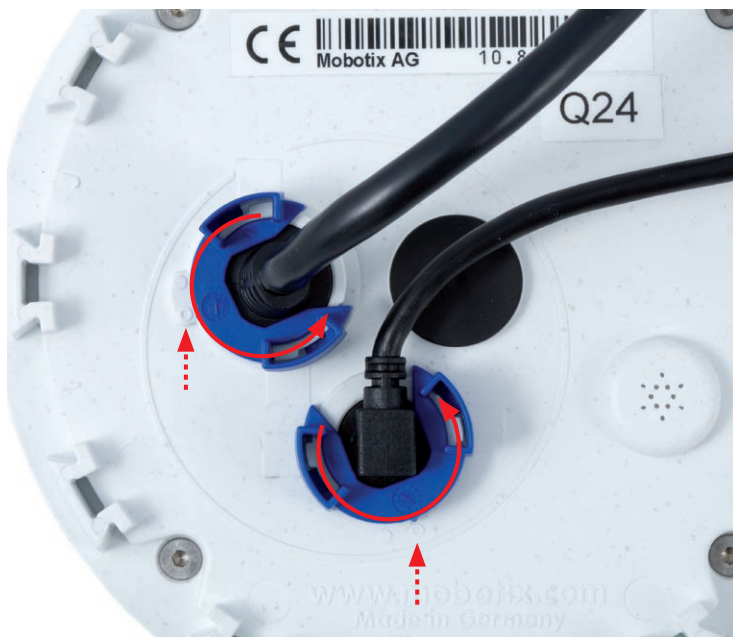

Caution

Only use **Original MOBOTIX cable** to connect the camera.

Standard cables purchased from other suppliers do not meet the necessary specifications for proper retention (no IP54 and IP65 weather protection).



Ethernet patch cable



MiniUSB cable

Replacing The Cable Retainer

Insert the cable into the receptacle on the camera. Position the bayonet catch from the side (opening points to the right). Rotate the bayonet catch clockwise to the "filled circle" symbol (see image). The cable is now properly retained.



Close the cable retainer by rotating the bayonet catch to the marked position

Bayonet catch open



Bayonet catch closed



2.5 Mounting The Camera With The On-Wall Set



2.5.1 Mounting Instructions

On-Wall sets available in 0° and 10° inclinations allow fast and simple installation of the Q24M on a wall or room ceiling. When using the set outdoors (IP65), ensure that the screw holes on the rear of the camera housing are sealed with the included foam rubber washers.

It is not possible to install the on-wall set directly above an on-wall or flush-mounted outlet.

Installation using the 10° On-Wall Set is often the right choice if a Q24M is to be used as a panorama camera installed at a greater than usual height (3 m or higher). Tilting the lens in the direction of the center of activity in the room maximizes image quality. Consider the desired camera position carefully during installation!

If discreet appearance of the Q24M is of particular importance, the In-Ceiling Set for ceiling installation is the best possible choice (see section 2.6).

The network connection and drill holes must be prepared correctly before installing the On-Wall Set (both indoors and outdoors):

- **Network connection:** You can use any one of the four openings in the On-Wall set to guide the cabling into the camera. The network cable must be fed through the opening without a connector. An additional connector to connect to the camera cable is required. When preparing for installation, keep in mind that the camera must later be positioned in the correct orientation, according to its purpose (OBEN / TOP arrow pointing upwards for wall installation, or in the direction of the longer wall for ceiling installation in rectangular rooms).
- **Preparing the drill holes:** Use the supplied drilling template for the Q24M On-Wall Set (fold-out at the end of this manual) to mark the position for drilling the anchor holes with regard to the camera position.

Caution

When using the On-Wall Set outdoors, ensure that the screw holes on the rear of the camera housing are sealed with the foam rubber washers included in delivery (IP65).

2.5.2 On-Wall Set



The On-Wall Set must be ordered separately from the MOBOTIX camera.

Item	Quantity	Part Name
2.1	1	On-Wall set housing
2.2	4	Stainless steel Allen screws M4x35 mm
2.3	4	Stainless steel washers Ø 4.3 mm
2.4	4	Foam rubber washers
2.5	4	Lock screws with counter nuts
2.6	2	Cable fitting with counter nut and O-ring cord

Drilling Template On-Wall Set

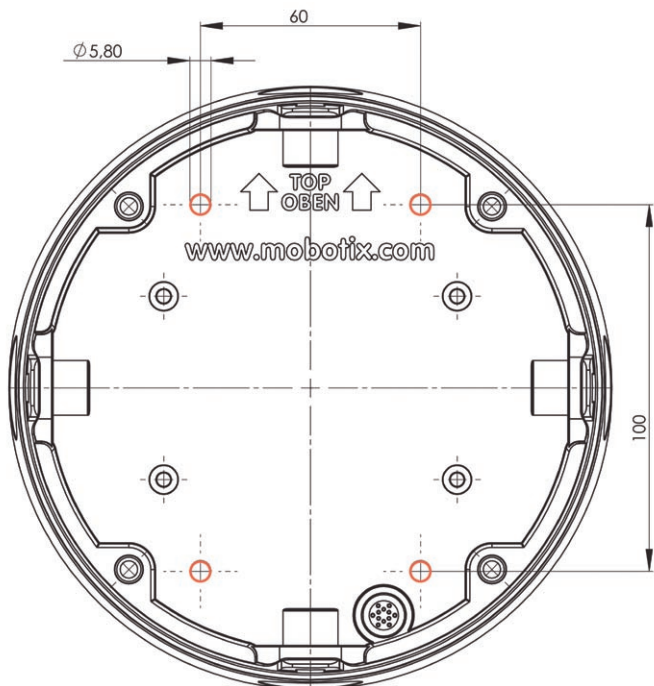

Find the drilling templates (scale 1:1) at the end of the manual as a fold-out



ø 160 mm



ø 166 mm

Notes

Use the fold-out template included at the end of the printed manual (valid for both 0° and 10° On-Wall Sets).

Make sure that the drilling template is not scaled or adjusted to the paper size when printing the PDF file (enlarged or reduced).

The maximum torque for all screws is 1 to 1.2 Nm.

Scope Of Delivery And Required Parts

Please check that all components supplied with the On-Wall Set are present in the original packaging first.

The Following Additional Tools Are Required For Installation:

- Suitable materials for ceiling/wall installation: **4 wood screws incl. screw anchors and washers** (e.g. from the original camera packaging).
- **Screwdriver**
- **Power drill** for screw anchor holes needed for ceiling/wall mounting
- **MOBOTIX Drilling Templates** (at the end of this manual)
- **Scissors** to cut out the template
- **Pen** to mark the drill holes
- Materials and tools needed to connect the pre-installed MOBOTIX network cable in the camera with the on-site network cable.
- **Soft cotton cloth** to clean the front of the lens



2.5.3 Procedure

1. **Attach washers:** Prior to installation, stick a black foam rubber washer around each of the four screw holes on the rear side of the on-wall housing (remove the adhesive foil and press into place, surface must be clean and free of grease). This prevents water from entering the housing.
2. **Prepare the cabling:** Insert the seal into the cable opening of the On-Wall Set such that the black rubber seal is on the outside. Fix it in place from the inside using a small hexagonal nut.
3. **Mount the On-Wall Set:** Mount the On-Wall Set (without the camera) at the intended position using e.g. the wood screws (included with Q24M camera, Pos. 1.13). Make sure the OBEN / TOP arrow points in the correct direction.
4. **Cable feeding:** Attach the counternut to the network cable, pass it through the seal from the outside and tighten the nut. The network cable is now screwed into the On-Wall Set, weatherproof. All unused openings must be sealed with the included sealant plugs. The cable passing into the housing must always be installed using the supplied three-part fittings.
5. **Remove the camera outer shell:** Unscrew all four Allen screws with the supplied Allen wrench. Remove the outer shell.

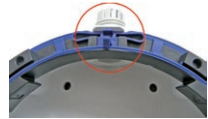

6. **Remove the mounting ring:** Separate the black mounting ring from the camera housing (lift the spring clip). This ring is not required when mounting the camera to the On-Wall set.

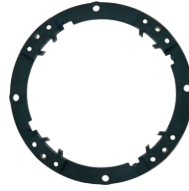

7. **Connect the cable:** Connect the on-site network cable to the network cable passing through the On-Wall Set using a standard connector. Excess cable can be stored easily within the On-Wall mount.



8. **Attach the camera to the mount:** The camera must be seated firmly within the On-Wall mount. The tapered guides at the back of the camera housing fit exactly into the openings of the On-Wall mount. Once, again, ensure that OBEN / TOP arrow points in the correct direction.



9. **Attach the outer shell:** Position the outer shell without the rubber seal and tighten all four Allen screws using the included Allen wrench.



10. **Clean the lens:** If necessary, gently clean the front of the lens with a soft cotton cloth. Do not apply excessive pressure to the surface of the glass when cleaning the lens.

11. **Establish a connection to the camera, check the image:** Establish a connection to the camera as described in sections 3.1 and above. The live image from the camera should be visible on the computer monitor. Check image sections on the computer monitor as well.

The decorative ring is available in different colors and in stainless steel

2.6 Mounting The Camera With The In-Ceiling Set



2.6.1 Mounting Instructions

The In-Ceiling Set offers the most stylish installation option for the Q24M. When properly installed, the only visible component is a particularly sleek and discreet hemispheric camera, while most of the remaining components are concealed inside the ceiling.

For these reasons, the Q24M installed with the In-Ceiling Set is the preferred option for most indoor spaces frequented by customers or the general public (e.g. hotels, restaurants, banks, retail stores, public buildings, etc.).

The common use of suspended ceilings in commercial and public buildings is an additional reason to place a preference on in-ceiling installation. The installation process is also simplified, as the network cable may be laid without difficulty and only a 15 cm diameter hole must be cut in the ceiling or ceiling component.

Before installing the MOBOTIX Q24M to an indoor location using the In-Ceiling Set, you must prepare the network connection and drill a hole for the camera:

- **Network connection:** The network cable is fed through the ceiling directly above the camera.

When preparing for installation, keep in mind (particularly with regard to cable slack) that the camera may later need to be repositioned in the correct orientation, according to its specific purpose (OBEN / TOP arrow pointing in the direction of the longer wall for ceiling installation in rectangular rooms).

- **Cut a hole for installation:** The hole should have a **diameter of 150 mm** (see drilling template at the end of the manual).

See section 2.1.2 for a detailed description

2.6.2 In-Ceiling Set

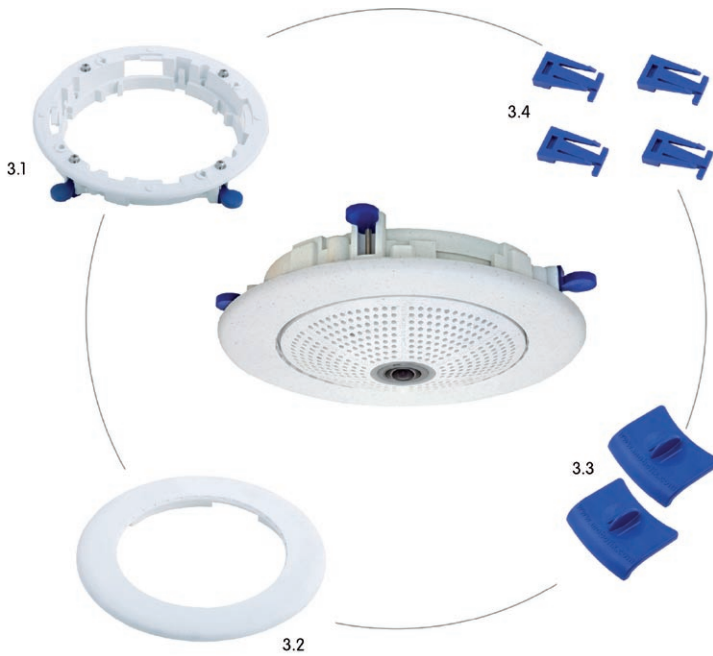

The In-Ceiling set must be ordered separately from the camera

Item	Quantity	Part Name
3.1	1	Ceiling mounting ring incl. 4 flat headed screws
3.2	1	Decoration ring
3.3	2	Wrench for In-Ceiling mount
3.4	4	Clamps

Q24M Drilling Template In-Ceiling Set

Find the drilling templates (scale 1:1) at the end of the manual as a fold-out

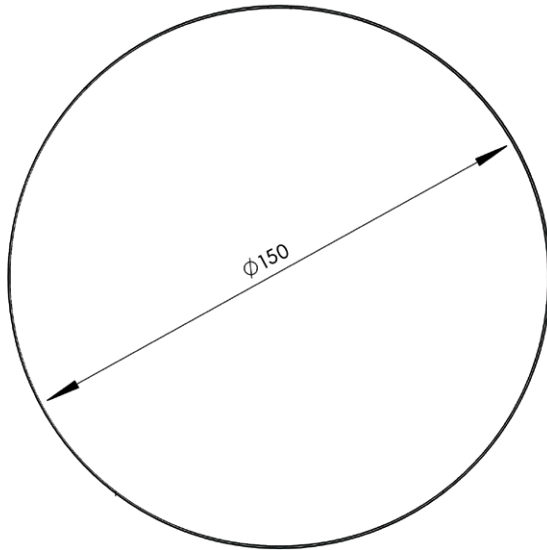

The In-Ceiling Set can be used in panels ranging from 6 to 22 mm in thickness

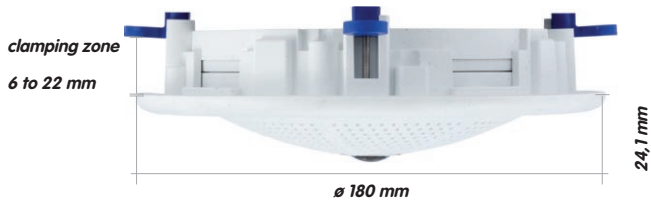
**Notes**

Find the folded drilling template at the end of the manual.

Make sure that the drilling template is not scaled or adjusted to the paper size when printing the PDF file (enlarged or reduced).

Scope Of Delivery And Required Parts

Please check that all components supplied with the In-Ceiling Set are present in the original packaging first.

The Following Additional Tools Are Required For Installation:

- **Power drill** with matching hole saw (150 mm diameter) or **jigsaw**
- **MOBOTIX Drilling Templates** (at the end of this manual)
- **Scissors** to cut out the template
- **Pen** to mark the hole positions
- **Two blue In-Ceiling wrenches** from the In-Ceiling Set
- Materials and tools needed to connect the pre-installed MOBOTIX network cable in the camera with the on-site network cable.
- **Soft cotton cloth** to clean the front of the lens



2.6.3 Procedure

1. **Prepare the network connection:** Run the network cable above the suspended ceiling and ensure that enough cable slack is available.
2. **Cut a hole for installation:** Cut a round hole for camera installation (e.g. with a 150 mm hole saw). Use the supplied cutting template of the In-Ceiling Set (fold-out at the end of the manual).

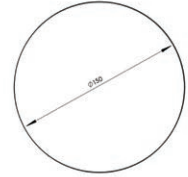

3. **Remove the outer shell:** Remove all four Allen screws using the supplied Allen wrench and lift off the outer shell.



4. **Remove the mounting ring:** Separate the mounting ring from the camera housing. This ring is not required when mounting the camera in the In-Ceiling Set.

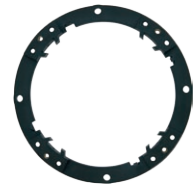

5. **Place the camera in the In-Ceiling Set:** The dovetail guides at the back of the camera housing fit exactly into the openings of the In-Ceiling mounting ring.



6. **Connect the cable:** Connect the on-site network cable to the camera network cable using a standard connector.

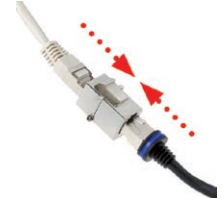

- 7. Insert the camera and the In-Ceiling Set into the hole:** Make sure that all winged cams are retracted before placing the In-Ceiling Set with the camera into the hole. Pay attention to the orientation: the OBEN / TOP arrow should point in the direction of the longer wall for ceiling installation in rectangular rooms. Tightening the screws of the In-Ceiling Set extends the winged cams, thus firmly holding the set in place.

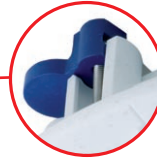

The blue winged cams (see left) automatically secure the In-Ceiling Set in the ceiling when tightening the screws

- 8. Install the decorative ring:** Use the two wrenches from the In-Ceiling Set to place the ring on the set as shown in the figure and turn the ring clockwise until it stops.



Installing the decorative ring: turn clockwise

The two **wrenches from the In-Ceiling Set** may also be used for **dismounting**. Insert them as shown and turn the ring counter-clockwise. Loosen the screws of the In-Ceiling Set; this will automatically retract the winged cams. You can now remove the In-Ceiling Set, with the camera still attached, from the ceiling.



Removing the decorative ring: turn counter-clockwise - only relevant when completely removing the camera

- 9. Clean the lens:** If necessary, gently clean the front of the lens with a soft cotton cloth. Do not apply excessive pressure to the surface of the glass when cleaning the lens.
- 10. Establish a connection to the camera, check the image:** Establish a connection to the camera as described in sections 3.1 and above. The live image from the camera should be visible on the computer monitor. Check image sections on the computer monitor as well.

2.7 Installing The Vandalism Set



2.7.1 Mounting Instructions

The Vandalism Set serves to provide additional security and protection for Q24M cameras. It may be installed with little effort and at low cost. This set is recommended for use under particularly demanding conditions (such as prisons, trouble areas, train stations, etc.). The set consists of a robust stainless steel cover for the camera housing (matt or polished) and an impact-resistant dome cover made of reinforced plastic.

To install the Vandalism Set, simply mount the stainless steel cover and the included security screws (with the four mounted spacers) over the standard housing.

2.7.2 Vandalism Set



The Vandalism set must be ordered separately from the camera.

Item	Quantity	Part Name
4.1	1	Stainless steel cover 2 mm stainless steel
4.2	4	Spacers for Vandalism set
4.3	4	Security screws M4x16 mm
4.4	1	Two-hole driver bit for security screws
4.5	1	Polycarbonate dome incl. washer
4.6	1	Lens wrench

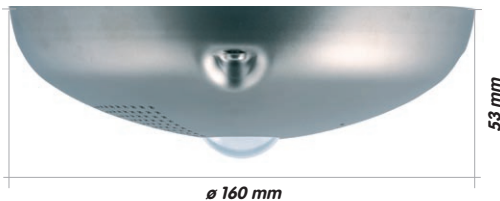

Available Variants Of The MOBOTIX Q24m Vandalism Set:



Stainless steel, polished



Stainless steel, matt

Scope Of Delivery And Required Parts

Please check that all components supplied with the Vandalism Set are present in the original packaging first.

The Following Additional Tools Are Required For Installation:

- **Allen wrench** for removing the standard outer shell (included in Q24M packaging)
- **Screwdriver with bit receptacle** for the two-hole driver bit
- Clean and soft **cotton cloth**

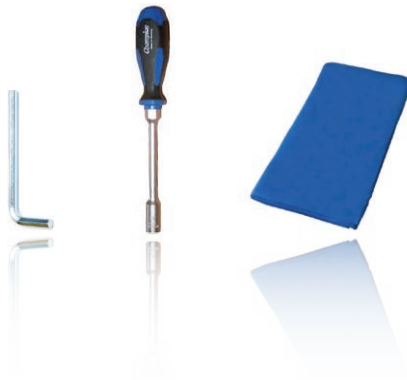

2.7.3 Procedure

In order to install the Vandalism Set, replace the white plastic outer shell of the Q24M, including the Allen screws, with the stainless steel cover, the security screws and the four spacers of the Vandalism set.

1. **Remove the outer shell:** Remove all four Allen screws using the supplied Allen wrench and lift off the outer shell.



2. **Remove the lens gasket:** Unscrew the lens using the lens wrench (included with the camera) and remove the lens gasket.



3. **Replace the lens:** Screw the lens back in using the lens wrench.



4. **Adjust the live image:** Establish a connection to the camera as described in sections 3.1 and above. The live image from the camera should be visible on the computer monitor. Select the highest available image resolution. Check image sections (image center and focus) on the computer monitor and adjust the lens with the lens wrench if necessary.
5. **Clean the lens:** If necessary, gently clean the front of the lens with a soft cotton cloth. Caution: Do not apply excessive pressure to the surface of the glass when cleaning the lens!

- Mount the dome:** Screw the dome on in a clockwise direction using the supplied wrench. If required, clean the dome gently using a soft cotton cloth before completing installation. Check the sharpness of the camera image again, and correct it if necessary.
- Mount the spacers:** Place the **four spacers** on the mounting ring.



Lens wrench for installing the dome

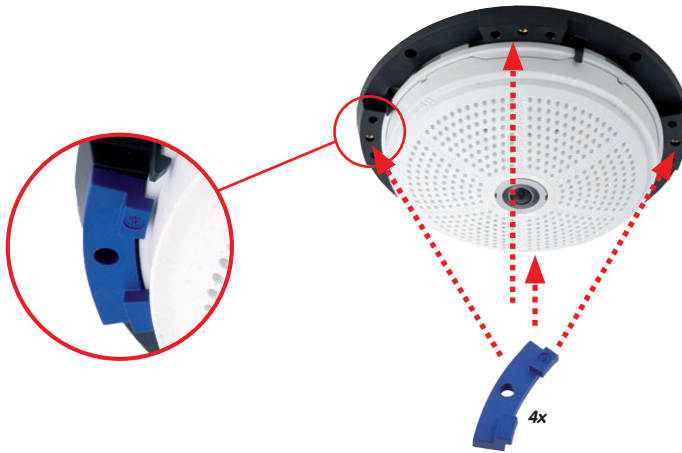

Spacers for Vandalism set

Maximum torque for all screws is 1 to 1.2 Nm

- Mount the stainless steel cover:** Position the stainless steel cover as shown and tighten the security screws using the included **two-hole driver bit**.



Security screw and two-hole driver bit

Stainless steel cover must be positioned correctly to line up with the LED openings

2.8 Installing The Wall Mount



2.8.1 Mounting Instructions

The Wall Mount allows you to easily mount Q24M cameras to walls or extensions, both indoors and outdoors. The camera remains IP65 weatherproof (dust-proof and resistant to water jets). The Wall Mount also covers RJ45 wall outlets and has ample space for additional modules (WLAN, batteries, etc.).

Before mounting the MOBOTIX Q24M with the Wall Mount, you must prepare the network connection and drill the holes for the fixtures:

- The **on-site network cabling** is passed through the opening in the back of the wall mount. The cable and the required (standard) connector for the camera cable (patch cable) are ideally protected by a robust wall sealing made from foam rubber. Nothing is visible or accessible from the outside. The Wall Mount may be mounted directly on top of flush or protruding wall outlets. Maximum width x height of the outlet: 88 mm x 80 mm.
- Only use the Q24M **factory installed patch cable** (50 cm cable length) or a MOBOTIX cable of different length available from the range of accessories.
- All openings of the camera housing need to be closed off properly. This is the only way to guarantee that the camera remains weatherproof.
- The included screw anchors should be used for the **drill holes** in the wall. Use the supplied drilling template for the Q24M Wall Mount (fold-out at the end of this manual) to mark the position for drilling the holes and the holes through which the cables will later be fed.



Direct installation
over on-wall and flush-
mounted wall outlets

2.8.2 Wall Mount

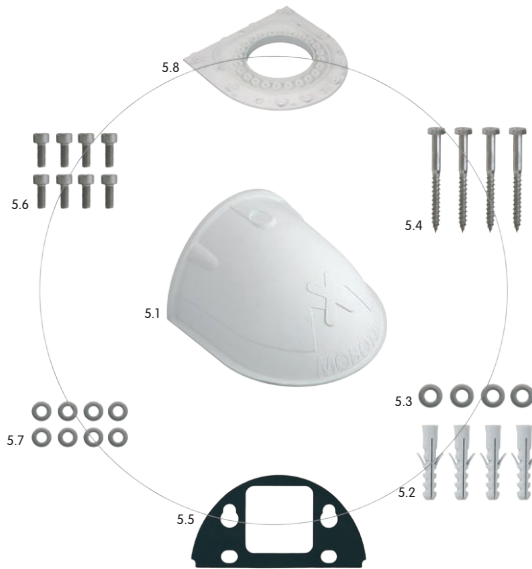

Item	Quantity	Part Name
5.1	1	Wall Mount
5.2	4	Universal screw anchors 8 mm
5.3	4	Stainless steel washers Ø 6.4 mm
5.4	4	Stainless steel wood screws with hex head 6x50 mm
5.5	1	Wall sealing
5.6	8	Stainless steel Allen screws M4x16 mm
5.7	8	Stainless steel washers Ø 4.3 mm
5.8	1	Bottom plate

Find the drilling templates (scale 1:1) at the end of the manual as a fold-out

Drilling Template Wall Mount

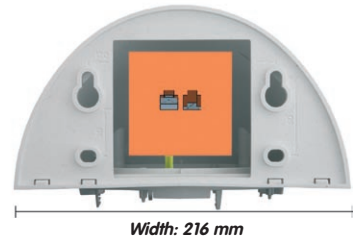
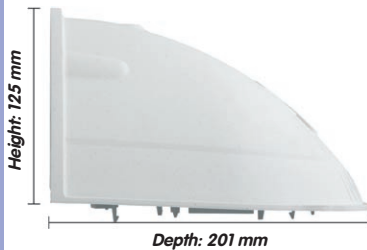
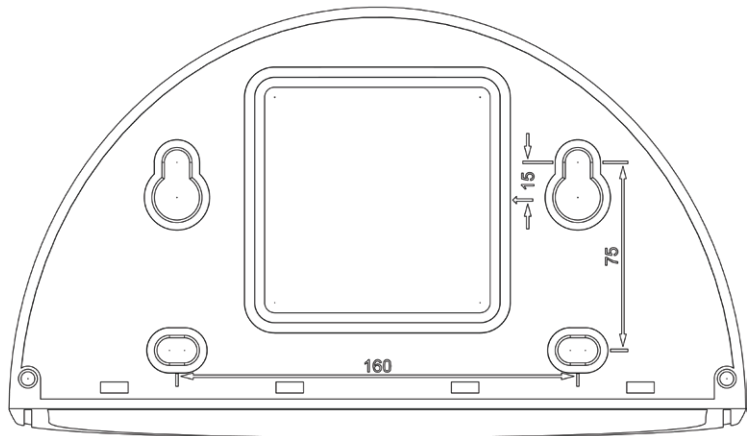

Notes

Find the folded drilling template at the end of the manual.

Make sure that the drilling template is not scaled or adjusted to the paper size when printing the PDF file (enlarged or reduced).

Scope Of Delivery And Required Parts

Please check that all components supplied with the Wall Mount Set are present in the original packaging first.

The Following Additional Tools Are Required For Installation:

- **Power drill** for screw anchor holes
- **Screwdriver**
- **MOBOTIX Drilling Templates** (at the end of this manual)
- **Scissors** to cut out the template
- **Pen** to mark the hole positions
- **Materials and tools** needed to connect the pre-installed MOBOTIX network cable in the camera with the on-site network cable.
- Clean and soft **cotton cloth**



2.8.3 Procedure

1. **Remove the camera housing:** Remove all four Allen screws using the supplied Allen wrench and lift off the outer shell. The screws and outer shell will be needed again shortly.



2. **Remove the camera mounting ring:** Separate the black mounting ring from the camera housing. This ring is not required when mounting the camera to the Wall Mount.

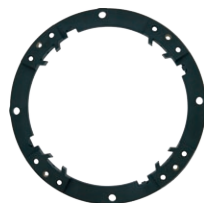

3. **Separate the bottom plate from the Wall Mount:** The bottom plate is used to hold the camera, and is only attached and screwed into place during a later step.



4. **Pass the camera cable up through the bottom of the bottom plate:** Ensure the orientation is correct. The spring clips should be on the underside of the bottom plate.



5. **Snap the camera into place on the bottom plate:** Firmly push the camera into the Wall Mount. The plastic spring clips will snap into place when the trapezoidal elements on the rear of the camera housing exactly match up with the corresponding openings on the Wall Mount. Pay attention to the direction of the camera (OBEN / TOP arrow pointing in the direction of the longer wall for ceiling installation in rectangular rooms).



6. **Mount the Wall Mount (without camera):** Stick the black wall sealing to the back of the Wall Mount (remove the adhesive foil first, the surface must be clean and free of grease). Pass the network cable through the large square opening and into the Wall Mount. Use the included screws to install the Wall Mount (without the camera) at the intended position. Pass the network cable through the large square opening on back side of the Wall Mount.



7. **Connect the cable:** Prepare the on-site network cable for connection with the camera patch cable using a standard connector. Excess cable can be stored easily within the Wall Mount.

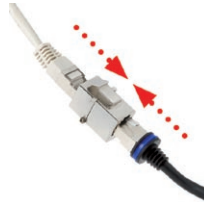

8. **Install the bottom plate with the camera in the Wall Mount:** Connect the camera patch cable to the network cable. Then mount the bottom plate with the camera in the slots from below and fix it in place on the Wall Mount using the 4 Allen screws (Allen wrench included).



9. **Attach the outer shell:** Position the outer shell (without the rubber seal) and tighten all four Allen screws using the included Allen wrench.



10. **Clean the lens:** If necessary, gently clean the front of the lens with a soft cotton cloth. Do not apply excessive pressure to the surface of the glass when cleaning the lens.

11. **Establish a connection to the camera, check the image:** Establish a connection to the camera as described in sections 3.1 and above. The live image from the camera should be visible on the computer monitor. Check image sections on the computer monitor as well.

2.9 Installing The Corner And Pole Mount



2.9.1 Mounting Instructions

The Corner and Pole Mount is made from stainless steel and is extremely robust and rustproof. It is used in combination with the Wall Mount described in section 2.8, in the case that a Q24M is to be installed on a pole or building corner. The Wall Mount required for complete installation must be ordered separately.

The mounting pole should have a diameter between 60 and 180 mm. Thanks to the 360° panorama view from above, installing the camera on the corner of a building makes it possible to monitor a range of approximately 270° from one building wall to the other (around the corner) with one single Q24M camera.

By design, the Corner and Pole Mount cannot be mounted above a wall outlet for the camera cabling.

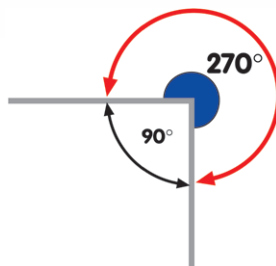

2.9.2 Corner And Pole Mount

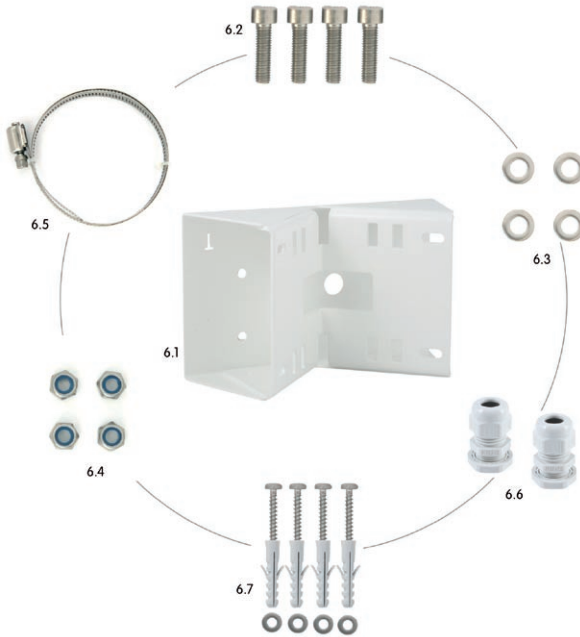

Item	Quantity	Part Name
6.1	1	Pole mount, stainless steel, white, powder-coated
6.2	4	Stainless steel Allen screws M6x20 mm
6.3	4	Stainless steel washers Ø 6 mm
6.4	4	Stainless steel lock nuts M6
6.5	2	Stainless steel straps
6.6	2	Cable fitting with counter nut and O-ring cord
6.7	4	Wood screws 6x80mm incl. screw anchors and washers

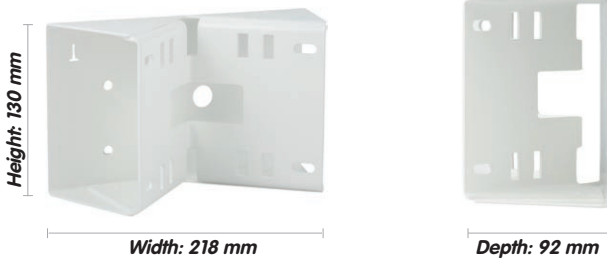

Scope Of Delivery And Required Parts

Please check that all components supplied with the Corner and Pole Mount Set are present in the original packaging first.

The Following Additional Tools Are Required For Installation As A Pole Mount:

- **Screwdriver**
- Materials and tools needed to connect the pre-installed MOBOTIX network cable in the camera with the on-site network cable.

The Following Additional Tools Are Required For Installation Of The Corner Mount:

- **Power drill** for screw anchor holes
- **Screwdriver**
- **Scissors** to cut out the template
- **Pen** to mark the hole positions
- Materials and tools needed to connect the pre-installed MOBOTIX network cable in the camera with the on-site network cable.



2.9.3 Mounting To A Pole



Use the supplied stainless steel straps to affix the Corner and Pole Mount to a pole.

- Guide the supplied **stainless steel straps** through the openings in the Corner and Pole Mount as shown in the diagram. Make sure that you are using the slots of the mount that fit best for the thickness of the pole. The stainless steel straps allow attaching the mount to poles with diameters between 60 and 180 mm.



- Guide the on-site network cable from behind through one of the large round holes of the Corner and Pole Mount. In order to properly protect the cabling, it is best to pass the cabling from the inside of the pole through the Corner and Pole Mount directly into the camera (concealed cabling). **Note: The cable length from the pole should be at least 80 cm!**



- Tighten the **stainless steel straps** on the Pole Mount with a screwdriver. If necessary, the ends of the straps can be cut off.



2.9.4 Mounting To A Wall Or Building Corner



Use the included screw anchors, screws and washers to affix the Corner and Pole Mount to a building corner.

- Mark the **four screw anchor holes** on the corner of the building, ensuring that the arrows on the mount point upwards. Drill the holes with a 10 mm wall drill.

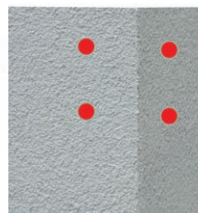

- Pass the on-site network cable through one of the large round holes at the back of the Corner and Pole Mount, then through one of the 16 mm diameter holes on the front of the mount. In order to properly protect the cabling, you should let the cabling run from the inside of the building through the Corner and Pole Mount directly into the camera (concealed cabling). **Note: The cable length from the building corner should be at least 80 cm!**

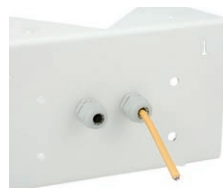

- Place the included **wall anchors** in the drilled holes and screw the Corner and Pole Mount into place on the corner of the building using the wood screws and washers. Use the supplied drilling template (fold-out at the end of this manual) to mark the positions for drilling the holes.
- Then: Install the Wall Mount on the Corner and Pole Mount (section 2.9.5).



2.9.5 Mounting The Wall Mount To The Corner And Pole Mount

- Feed the cables **through the appropriate hole at the back** of the Outdoor Wall Mount. The wall sealing on the Wall Mount must be in place already (see section 2.8).
- Use the 6 x 20 mm Allen screws, Ø 6 mm washers and M6 nuts included with the Corner and Pole Mount and **attach the Wall Mount to the Corner and Pole Mount**.
- Then continue with the remaining work steps described in section 2.8.3!



2.10 Replacing The MicroSD Card

The camera must be taken down to remove, insert or replace a MicroSD card. To avoid data loss, be sure to deactivate MicroSD card recording in the camera software and reboot the MOBOTIX camera before removing the card.

Caution

A MicroSD card may only be removed from the camera after you have deactivated Recording to SD Card and rebooted the camera. Failing to do so may lead to data loss!

2.10.1 Removing The MicroSD Card

1. **Deactivate recording:** Recording to MicroSD card must be deactivated (**Admin Menu > Storage on External File Server / Flash Device**). If MicroSD card recording is still active, deactivate recording and reboot the camera. Section 3.4, Micro SD Card Recording, contains more information on this topic.

2. **Remove the outer shell:** Remove all four Allen screws using the supplied Allen wrench and lift off the outer shell.



3. **Remove the connection cables:** The connected cables (patch cable, MiniUSB if present) must be removed from the camera first by rotating and opening the bayonet catch (see end of **section 2.4.3**).



4. **Remove the back of the camera and take out the MicroSD card:** Remove the four screws from the back plate using the supplied 2 mm Allen wrench and carefully lift off the back plate. Gently push on the MicroSD card in the card slot of the camera. The card will be released from the slot and can then be removed from the camera.



Bayonet catch open



Carefully loosen the rear casing at the 4 openings on the side with a screwdriver before removing it



Push-push function: only remove the MicroSD card after first gently pushing it in



To use the camera without a MicroSD card, continue with step 2 in section 2.10.2 (Mount the Back Plate).

2.10.2 Inserting A MicroSD Card

- 1. Insert the MicroSD card:** Push the MicroSD card into the card slot as shown, until an audible and perceptible click indicates it is in place.
- 2. Mount the back plate:** Replace the back plate of the camera housing, ensuring that the back plate screw holes are correctly positioned above the thread inserts.
- 3. Screw the back plate tight and replace the connection cables:** Place the four Allen screws back into the back plate and tighten the screws using the supplied 2 mm Allen wrench. The previously removed patch cable must now be reconnected (see end of **section 2.4.3**).
- 4. Attach the outer shell:** Replace the outer shell and screw all four Allen screws tight using the supplied Allen wrench.
- 5. Activate recording:** If you have inserted a MicroSD card that has already been MxFFS formatted, you can activate recording under Admin Menu > Storage on External File Server / Flash Device. Once the camera has been rebooted, it automatically activates recording.
- 6. If you have inserted a new MicroSD card,** it must first be formatted as described in section 3.4, MicroSD Card Recording.



Push-push function:
insert the MicroSD
card and push it gently



Bayonet catch closed



2.11 Network And Power Connection

2.11.1 Notes On Cable Lengths And Power Supply

- Power may only be supplied to the camera via its Ethernet connector. A MOBOTIX Power Adapter or similar high-quality PoE product is recommended to provide the power supply via the network cable (see section 2.3, *Available Q24M Accessories*):
 - **one camera:** with the Network Power Adapter (MX-NPA-PoE)
 - **multiple cameras:** with quality PoE products conforming to IEEE 802.3af
- The **maximum length** of the network cable for power supply over an Ethernet cable is **100 m**.
- Make sure that you only use switches or routers that support the **10/100 Mbps Ethernet interface** of the camera. Check for LED activity on the corresponding port of the switch or router. When deploying several cameras, read the notes in section 4.11, *Operating Multiple Cameras*, in the *Software Manual*.
- It is highly recommended to use uninterruptible power supplies (UPS) to provide backup power.
- If you are using IEEE 802.3af Power over Ethernet network components to supply power to MOBOTIX cameras, make sure, if possible, that these components do not have a fan. Since the power consumption of MOBOTIX cameras is very low compared to other products, the reliability of the entire system is increased, thus extending the life of these components.

2.11.2 PoE Variables

The power consumption of the camera depends on the functions in use as well as any connected expansion modules (see table). PoE classes 1, 2 or 3 may be selected in the browser-based user interface in order to optimally adjust the camera to your system design (PoE switch in use, emergency power concept, etc.).

PoE power level classes (IEEE 802.3af standard):

Class	Max. power consumption	Possible camera functions
1	0.44 W - 3.84 W	Normal operation without audio output and without USB devices
2	3.84 W - 6.49 W (factory default)	Normal operation with audio output and USB devices
3	6.49 W - 12.95 W	Like Class 2 and also with MxBus devices

MOBOTIX factory default is class 2

The **MOBOTIX** factory default is **Class 2**. This default is usually fine and nothing needs to be changed. However, if the lower power level class 1 is sufficient for your application, it may - due to possible internal power distribution schemes amongst the ports of the PoE switch in use - be advantageous to change the PoE power level class in the browser:

1. Select **Admin Menu > Network Setup > Ethernet interface** (for experts).
2. Under Power Supply, click **Change**.
3. A **Power Wizard** will appear to guide you through the PoE configuration steps.
4. The camera will then need to be cycled through a hard reboot. **Disconnect the camera from the power supply, then reconnect it, e.g. by disconnecting, then reconnecting the network cable at a PoE switch.**

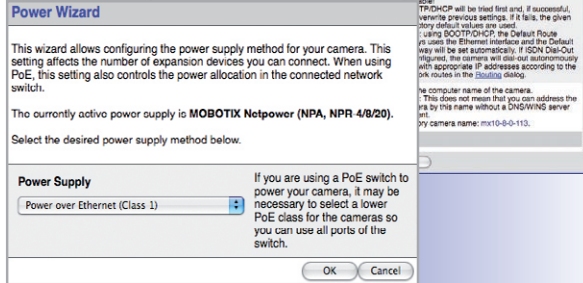
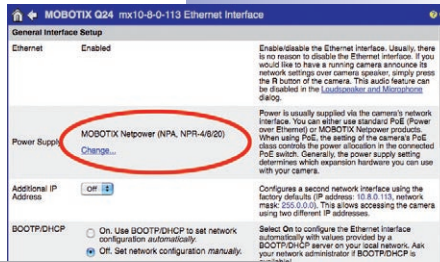

2.11.3 Power Supply Using A Switch

1. Connect the factory pre-installed cable of the camera to the **Camera** connector of the Network Power Adapter.
2. Connect the **LAN/Power** connector of the NPA to an Ethernet connector of the switch/router or the Ethernet wall outlet.
3. Plug the RJ45 connector of the external power unit into the **PC/Power** connector on the Network Power Adapter.

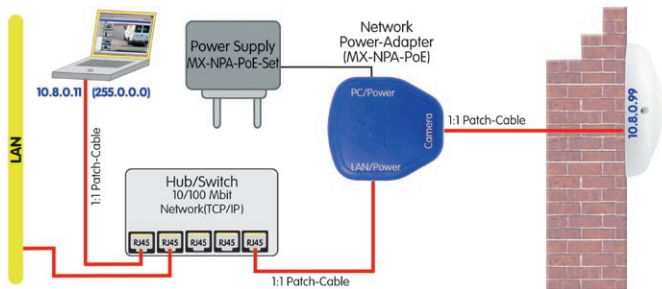

IP addresses in the diagram are shown only as an example

For the Q24M, you should use the new blue MX-NPA-PoE Set - previous MOBOTIX network power accessories such as the NPA Set, Power Box and Power Rack (MX-NPA-Set, MX-NPR-4 and MX-NPR8/20) are not suitable for use with the Q24M



IP addresses in the diagram are shown only as an example

For the Q24M, you should use the new blue MX-NPA-PoE Set - previous MOBOTIX network power accessories such as the NPA Set, Power Box and Power Rack (MX-NPA-Set, MX-NPR-4 and MX-NPR8/20) are not suitable for use with the Q24M



2.11.4 Power Supply When Connected Directly To A Computer

1. Connect the factory pre-installed cable of the camera to the **Camera** connector of the Network Power Adapter.
2. Connect the **PC/Power** connector of the Network Power Adapter to the Ethernet port of the computer.
3. Plug the RJ45 connector of the external power unit into the **LAN/Power** connector on the Network Power Adapter.



2.11.5 Power Supply (PoE IEEE 802.3af) Using Power-over-Ethernet Products

Connect the factory pre-installed cable of the camera to the Ethernet connector of the PoE switch/router. The switch/router must support the PoE standard IEEE 802.3af.

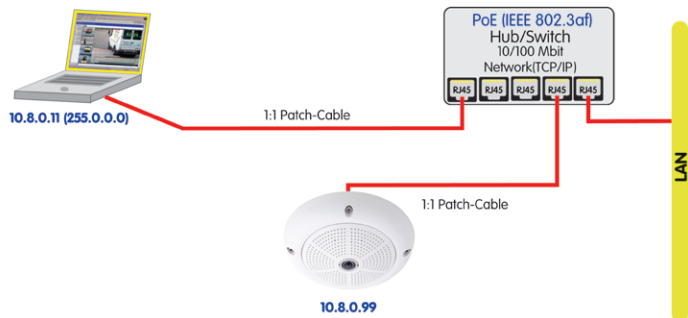

IP addresses in the diagram are shown only as an example

2.11.6 Camera Startup Sequence

As soon as the camera's power supply has been established, the two LEDs will show the progress of the startup sequence (see section 5.4.3, *LED Signals and LED Configuration*, in the *MOBOTIX Camera Software Manual Part 2*).

- **Booting:** Immediately after connecting the power supply, the red LED lights up, blinks for two seconds, then stays on permanently red. A camera self-test is carried out at this point, and the entire system is started. In case of an error, the camera will start using the backup system.
- **Waiting for key pressed:** Both LEDs light up for four seconds. If you press the **R or L key of the camera** during this time, the camera will execute the corresponding function (see sections 3.2.5 und 3.2.6, *Starting the Camera with IP Address*).
- **Ready:** Once the camera software has been started, the green LED is on permanently and the red LED blinks. You can now reach the camera via the network using a browser.



Notes

During the startup sequence of the camera, the LEDs will always light up, even if they have been deactivated in **Admin Menu > LED Setup**.

3 OPERATING THE CAMERA

3.1 Manual And Automatic Operation - Overview

MOBOTIX cameras do not require any extra software. Thus, you can set up and operate the MOBOTIX camera using a JavaScript-enabled browser on all common operating systems (such as Windows, Linux, Macintosh, etc.). As an alternative, you can also use the MOBOTIX applications MxControlCenter and MxEasy. Follow these steps to set up the camera:

1. **Connect the camera to the network.** Power is supplied directly via the network cable (see section 2.11)
2. **Set up the camera's network parameters:**
 - **Manually using a web browser** (see section 3.2.1, then section 3.2.2)
 - **Automatically using MxControlCenter/MxEasy** (see sections 3.2.3 and 3.2.4) or **via DHCP** (see section 3.2.5)
3. **Configure the camera** using the browser-based user interface.

Every MOBOTIX camera comes preconfigured with a fixed IP address in the 10.x.x range (e.g. 10.8.0.99). However, local computer networks usually have IP addresses in the 172 or 192 ranges. In order to access a MOBOTIX camera via the network, the camera needs to obtain an IP address in the same address range. You can **set up the network parameters of the MOBOTIX camera using one of the following methods: Manually, using MxCC and MxEasy** or by **DHCP**.

Camera software
in the browser



3.1.1 Manually Using A Computer In The 10.X.X.X IP Address Range

You can set up the camera's network parameters using a browser and the embedded camera software. To do this, connect the camera to a computer or a network that is using a 10.x.x.x IP address range (see section 3.2.1, *Manually Setting Up the Network Interface*). Once this has been completed, you can enter the camera's default IP address in the browser address bar of the computer (see section 3.2.2, *The First Images and the Most Important Settings in the Browser*). Next, click on the **Admin Menu** button to open the camera's user interface. This is where you can configure the desired network parameters of the camera. Once you have completed the Quick Installation, you can connect the camera with its new network parameters to the desired network.

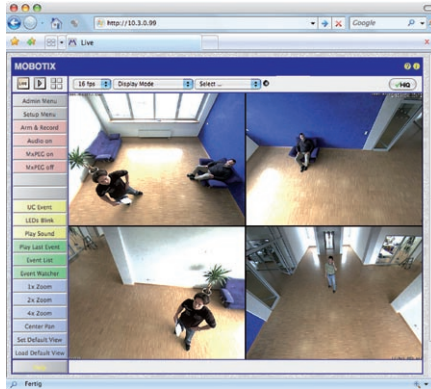

Surround View: One Q24M replaces 4 standard cameras

Advantages

- The camera does not need to be physically accessible, i.e. it can remain mounted to a pole, for example.
- No additional software is required.
- The network parameters can be set flexibly through manual entry.

Disadvantages

- The computer or the network need to operate in the 10.x.x.x IP address range or need to be able to access such a network.
- The setup does not work automatically.
- You need to know the relevant network parameters.

3.1.2 Automatically Using MxControlCenter Or MxEasy

You can set up the camera's network parameters using the free-of-charge video management software MxControlCenter or MxEasy (see sections 3.2.3 and 3.2.4). You can also use one of these applications to automatically configure the network parameters of MOBOTIX cameras that are not operating on the same IP address range as the computer.

MxControlCenter control center software (free download from www.mobotix.com)



MxEasy (free download from www.mobotix.com)



Advantages

- You can connect the camera directly to the target network.
- The camera does not need to be physically accessible, i.e. it can remain mounted to a pole, for example.
- The camera can be configured to automatically receive an IP address (optional).
- The network parameters can be manually set (optional).
- You do not need to access the camera user interface.

Requirement

- The MxControlCenter or MxEasy video management software needs to be installed on the computer.

3.1.3 Automatically Using DHCP

The camera can automatically obtain its network parameters using DHCP. This requires the network to have a functioning DHCP server (e.g. a DSL router with activated DHCP server) and the camera must be booted using DHCP (see section 3.2.5, *Starting the Camera With an Automatic IP Address (DHCP)*). The IP address automatically assigned by the DHCP sever will be announced via the camera speaker as soon as the camera has booted successfully.

Advantages

- You can connect the camera directly to the target network.
- Network parameters are automatically assigned.
- No additional software is required.
- You do not need to access the camera user interface.

Disadvantages

- The camera needs to be physically accessible, as you need to press a key on the camera to boot it using DHCP.
- Requires a functioning DHCP server on the network.

3.2 First Images And The Most Important Settings

Once the camera has been connected to the network, you need to set up the camera's network interface accordingly. This step involves setting up and checking the network parameters of the camera. If your network is already using an IP address in the 10.x.x.x range with a 255.0.0.0 network mask, you do not need to change the camera's network parameters. You can access the camera directly (see section 3.2.2). If your network or computer does not use an IP address in the 10.x.x.x range (e.g. in the 192 or 172 ranges), you should follow one of the following methods for changing the camera's network parameters:

- **Manual Setup** (Section 3.2.1)
- **Automatic Setup using MxControlCenter or MxEasy** (Sections 3.2.3 and 3.2.4)

Notes

For the following examples, we will use a camera with the factory address 10.8.0.99. Replace this IP address with the IP address of your camera. You will find the IP address of your camera on a small sticker on the camera. Make sure that the IP addresses used in the following examples are not already being used by other devices in the network.

Hint: Pressing the "**R**" key on the camera (see section 2.2.2) prompts the camera to announce its current IP address over the speaker.

3.2.1 Manually Setting Up The Network Parameters In A Browser

In order to manually set up the network parameters of the MOBOTIX camera, you need a computer that is using a 10.x.x.x IP address. For this purpose, the computer's network parameters usually have to be changed.

1. Change The Network Parameters Of Your Computer:

Windows (2000, XP and Vista):

1. Open **Start > Settings > Control Panel > Network Connections**. Clicking **Properties** opens the dialog shown.
2. Double-click **Internet Protocol (TCP/IP)**. On the **General** tab, activate the *Use the following IP address* option. Enter an IP address in the 10.x.x.x range in this field (e.g. 10.8.0.11).
3. Once all dialogs have been closed, the computer will have the IP address 10.8.0.11.

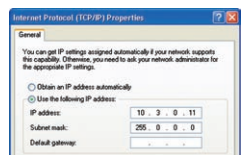
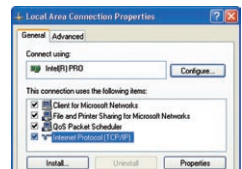

Caution: Netmask 255.0.0.0

Linux/Unix:

1. Open a terminal as `root` user.
2. Enter the following command: `ifconfig eth0:1 10.8.0.11`
3. The computer is now also using the IP address 10.8.0.11.

Mac OS X:

1. Open **System Properties > Network**.
2. Select **Ethernet**. In the **Configuration** field, select **Manual** and enter a 10.x.x.x IP address (e.g. 10.8.0.11).
3. Click **Apply** on the bottom right-hand side of the dialog to assign the computer the IP address 10.8.0.11.

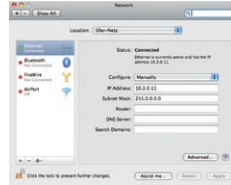

2. Set Up The Target Network Parameters Of The Camera:

1. Open a web browser on the computer and enter the default IP address of the MOBOTIX camera in the address bar of the browser (e.g. 10.8.0.99). Pressing Enter displays the user interface of the MOBOTIX camera (see also section 3.2.2, *First Images and the Most Important Settings in the Browser*).

2. Click the **Admin Menu** softbutton in the user interface of the MOBOTIX camera. The Quick Installation starts automatically once the `admins` user has logged on.

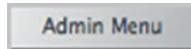

Note: The Quick Installation can also be executed at a later stage by opening **Admin Menu > Network Setup > Quick Installation** (see also section 5.2, *Quick Installation*, in the *Camera Software Manual Part 2*).

3. Enter the target network parameters of the camera on the appropriate page of the Quick Installation assistant.

Note: The network parameters can also be accessed at a later stage by opening **Admin Menu > Network Setup > Quick Installation**.

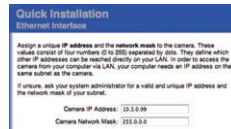

4. Once you have completed the Quick Installation and rebooted the camera, the new network parameters will be activated. The camera can now be connected to the target network and, if required, further configured.

User Name: `admin`
password: `meinsm`

3.2.2 First Images And Configuration In The Browser

Once the MOBOTIX camera has been connected to the power supply and to the network, you can access the user interface with the live camera image in the web browser. Internet Explorer, Firefox, Safari, Konqueror, Opera, Camino or any other graphical browser with activated JavaScript is suitable. It does not matter which operating system is used.

After entering the camera's IP address in the browser address bar, you will see the live screen of the MOBOTIX camera with its user interface controls, such as softbuttons, buttons for the different camera screens, pull-down menus (Quick Controls), icons for accessing the online help and the camera status as well as status information elements above and below the live image.

Camera access:
http://10.8.0.99 (example)

The factory IP address is printed on a sticker on the camera housing

Administration menu:
User Name: **admin**
password: **meinsm**

Softbuttons are freely configurable

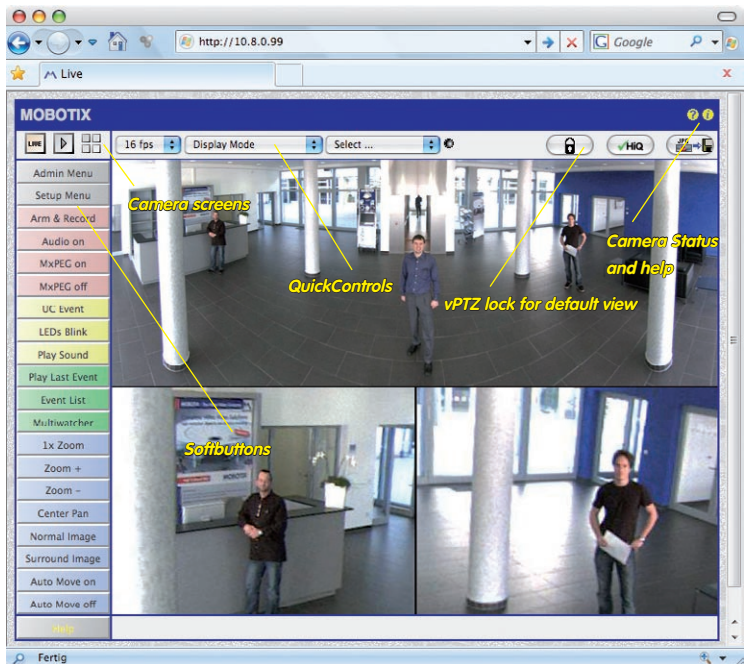

Notes

Default access credentials for the Administration Menu

User Name: **admin**

Password: **meinsm**

Camera Screens: Live, Player, Multiview

The MOBOTIX camera automatically displays the **live** screen when it starts up (factory default setting). You can set a different start page in **Admin Menu > Language and Start Page** (e.g. the **Guest** screen) to allow a restricted access to the live image.

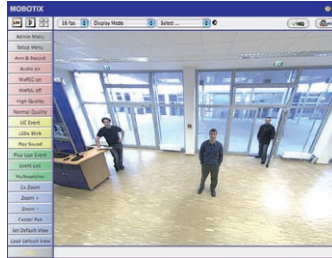

The other available standard screens include **Player** (playback of recorded images and video sequences) and the **Multiview** screen (displays several cameras with live or recorded images).

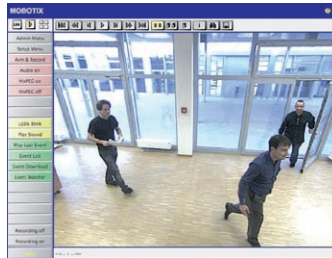

Multiview allows you to view several cameras via a "proxy" camera (especially useful if you want to access your cameras from outside of the network with reduced bandwidth) and the **PDA** mode provides a special screen for mobile devices.

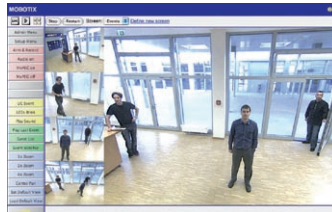

Note

For more information on camera screens, see section 4.1.1, *Camera Screens in the Browser*, the *Camera Software Manual Part 2* or the online help of the camera's browser interface.



Live screen: <http://<camera IP>/control/userimage.html>



Player screen: <http://<camera IP>/control/player>



Multiview screen: <http://<camera IP>/control/multiview>

PDA Screen: <http://<camera IP>/pda>

PDA Event List: <http://<camera IP>/control/player?eventlist&pda>

Guest screen: <http://<camera IP>/cgi-bin/guestimage.html>

Download MxControlCenter
free of charge from
www.mobotix.com

3.2.3 First Images And Network Parameter Configuration In MxControlCenter

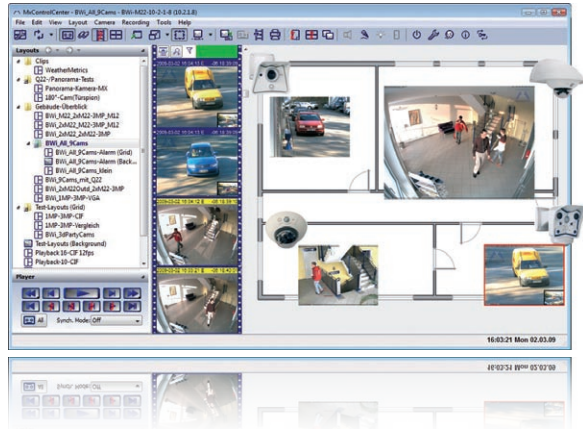

Installation

If you have a MxControlCenter installation CD, insert it into the CD/DVD drive of your computer.

If you do not have the installation CD or would just like to install an update, you can download the latest Windows Installer from the **MOBOTIX website as an MSI file** and install it manually. The latest versions are available under www.mobotix.com in the **Support > Software Downloads > MxControlCenter section**.

If you insert the installation CD, the installation process will start automatically and you will be guided through the necessary steps. If you have downloaded the latest Windows Installer, double-click the MSI file to initiate the installation process.

The Installer copies the selected files to the computer (older versions will be removed automatically) and then creates the designated shortcuts during the installation process (Desktop, Start Menu, etc.).

Caution

MxControlCenter will automatically attempt to find all MOBOTIX cameras in the physically connected network (i.e. even a MOBOTIX camera with a factory IP address of 10.x.x.x). Make sure that the **firewall settings** on your computer are low enough so that MxControlCenter is not blocked. If MOBOTIX cameras are found, MxControlCenter can automatically **reconfigure** them so that they are available in the current subnet of the computer. If you do not have permission to modify these settings on your computer, contact your system administrator for assistance.

Searching And Displaying

Launch MxControlCenter after successful installation (see section *Installation*) by double-clicking the shortcut that was created by the Installer or the executable MxCC . exe file in the installation directory on your computer.

When MxControlCenter is launched for the first time, the **Add Cameras: Search and Select** dialog opens and the application automatically searches for MOBOTIX cameras in the local network. To perform a camera search at a later time, choose **Video Source > Add**

If your MOBOTIX camera is properly connected, it should appear together with the existing video sources in the following list:

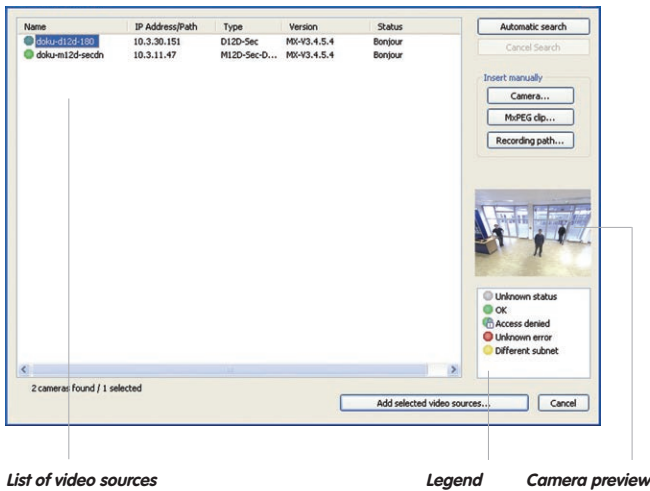



Automatic search for MOBOTIX cameras!

Note

Video sources in this context not only refer to MOBOTIX cameras, but also to third-party IP cameras, file server paths, MxPEG clips and analog cameras connected via MxServer (e.g. analog dome cameras). These video sources are not found automatically and need to be added manually.

Cameras Are Found But Are Located In A Different Subnet

The symbols in the first column and the legend in the dialog indicate whether you can access a particular camera directly from the MxControlCenter, which is the case for all cameras designated with  (OK). Cameras designated with  (different subnet) are located in a different subnet. This usually applies to new cameras or cameras that have been reset to their factory settings.

Note

The MxControlCenter finds all MOBOTIX cameras, even when the computer and the cameras are not located in the same subnet.

Select the cameras that you would like to display in a Layout (a view with cameras) and click **Add selected video sources**.

The **Create new layout?** dialog will appear. You can choose to either create a new layout with the cameras that have been found or simply add those cameras to the MxControlCenter.

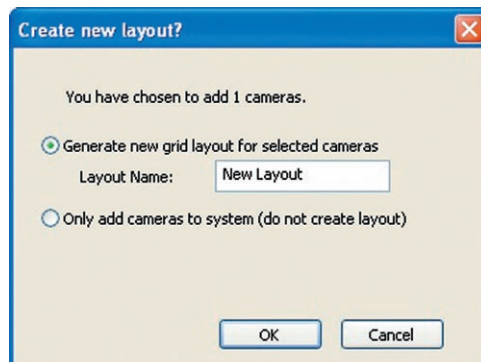

If some of the selected cameras are in different subnets, MxControlCenter displays the following dialog:

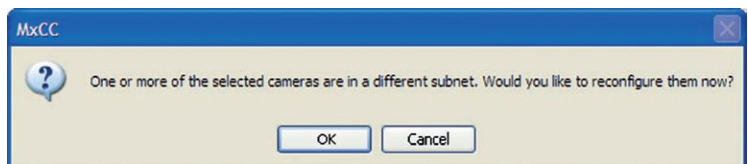

Click **Yes** to reconfigure the cameras for your specific network area.

First Images And The Most Important Settings

Reconfiguring Cameras In A Different Subnet

In most networks, a **DHCP server** will automatically assign the IP addresses for network devices so that you can apply the default settings in the **Configure camera** dialog (**Get IP address automatically**). If you would like all cameras to obtain IP addresses automatically, select the **Apply to all selected cameras** checkbox.

If the IP addresses for devices on the network are permanently assigned, ask your network administrator for the appropriate IP addresses for the cameras. Once you have that information, enter the correct **IP address** and **subnet mask** for each camera in the **Use the following IP address** option.

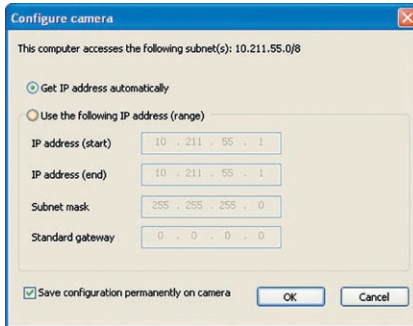

Make sure that the **Save configuration permanently on camera** checkbox is selected so that the cameras can be found at the designated IP address when you restart your computer.

Now wait until MxControlCenter has modified the network settings of the cameras and restarted the computer. The status of the reconfigured cameras changes from **(different subnet)** to **(OK)**. Confirm the **Open Video Sources** dialog again by clicking **OK**.

Defining Additional Video Sources

In addition to the MOBOTIX cameras that are found automatically, you can also manually add video sources to the list of video sources for MxControlCenter .

- **Camera:** Here, you can enter the known IP address or DNS name of a MOBOTIX camera or a third-party IP camera if it was not found by the automatic search feature.
- **MxPEG-Clip:** Adds an MxPEG video clip previously recorded by a MOBOTIX camera as a video source.
- **Recording path:** Adds the path of an external file server where a MOBOTIX camera has recorded audio/video data. The videos or images recorded at that location can now be played back using the **Player** or **Video Search** .

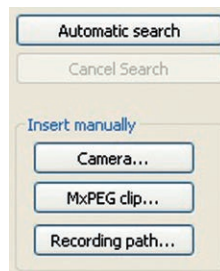

Selecting Video Sources

In this list you can now select the video sources that you would like to display and manage in MxControlCenter .

Camera Preview

If you select one camera with the status *OK*, MxControlCenter automatically displays the **live images from that camera in the preview window**. If you are using [Ctrl]-click to select additional cameras, the image from the camera selected last is shown in the preview window. This feature makes it easier for you to identify the cameras that you would like to use.



Editing The Video Source List

Right-click this list to open a shortcut menu from which you can select all video sources or cancel the selection. You can also use this method to remove from the list some or all of the video sources that you would not like to display or manage in MxControlCenter.

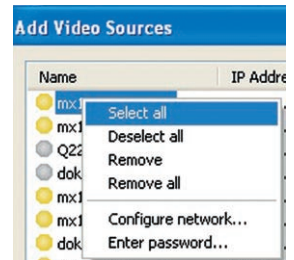

If you have cancelled the camera configuration process or need a password that differs from the camera's factory default password, you can also configure the camera from the shortcut menu at a later date and enter the user name and password required for reconfiguration at that time.

It is also possible to open the **Configure selected cameras** dialog using the context menu in order to change the camera network parameters.

Adding Selected Video Sources In A New Layout

Click **OK** to add the selected cameras in MxControlCenter. If you select the **Generate new grid for selected cameras** option in the **Create New Grid Layout** dialog, MxControlCenter will automatically create a grid layout that displays all selected video sources in equal-sized windows.

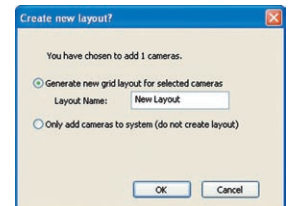

Otherwise, the selected video sources will only be added to the MxCC system and can then be used to create layouts at a later date.

Download MxEasy
free of charge from
www.mobotix.com

3.2.4 First Images And Network Parameter Configuration In MxEasy



Installing MxEasy

If you have an MxEasy installation CD, insert it into your CD/DVD drive. The assistant will guide you through the installation process. If this is not the case or if you would like to update to a newer version, you can download the latest MxEasy version for your operating system from the MOBOTIX website (www.mobotix.com > **Support** > **Software Downloads** in the **MxEasy** section).

Using MxEasy For The First Time

To start MxEasy, double-click the shortcut or the program file itself.

Automated Search For MOBOTIX Cameras

If you start MxEasy for the first time on a computer, the Camera Selection dialog will appear, showing all detected MOBOTIX cameras. The camera list will be updated automatically as soon as new cameras are connected to or removed from the network.

MxEasy also automatically monitors and displays the operating status of all cameras. Cameras that are not on the same subnet as the computer

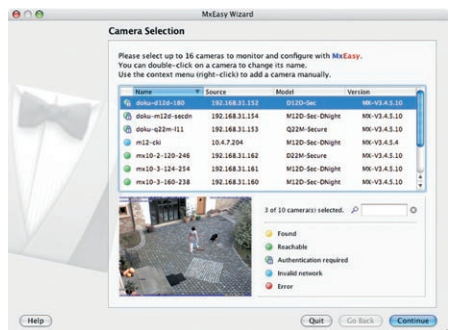

will get a differently colored icon than the cameras that are on the same subnet. Likewise, the cameras that have an unknown password or for which no user name/password combination has been specified in MxEasy will be displayed in a different color.

If all the desired MOBOTIX cameras are highlighted as **Accessible** in the video source list, you can proceed to the *Selecting Cameras* section below. Cameras with the status **Invalid Network** can be reconfigured for the "proper" subnet, as described in the following section.

Configuring MOBOTIX Cameras For A Different Network

Using Bonjour, MxEasy finds not only cameras on the same network as your computer, but also MOBOTIX cameras located in other subnets (Status **Invalid Network**). In such a case, you would not be able to establish any connection to cameras in a different network or subnet (without going into much further detail about the specific details of TCP/IP network configurations). This is possible, for example, when a camera with a factory IP address is connected to a network in which a DHCP server automatically assigns the IP addresses. MxEasy can automatically configure such a camera so that it is "integrated" into your existing network. To do so, simply highlight the desired camera in the list.

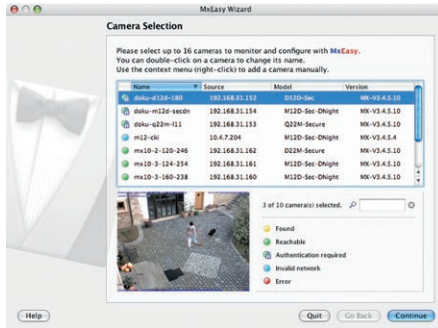

Clicking **Next** displays a security prompt; if you click **OK**, the dialog for reconfiguring the selected camera will appear.

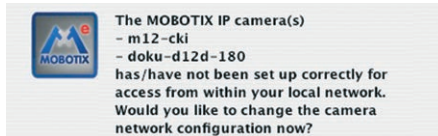

If your computer automatically obtains its IP address from a DHCP server, then this is certainly the best choice for that specific camera and most likely for all other cameras that have been found in a different subnet (**Get IP address automatically** option). If you have assigned a fixed IP address to your computer, you will probably want to assign fixed IP addresses (issued by your system administrator)

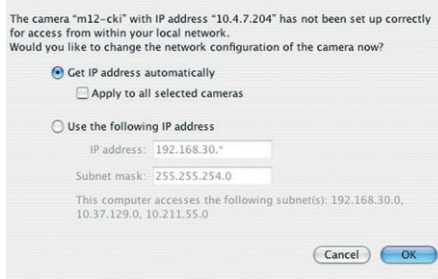

to every camera (**Use this IP address** option). Here, for the most part, you should enter a similar configuration as in the network settings of your computer.

Once you click **OK**, the selected cameras will be reconfigured automatically. All reconfigured cameras will then be running in the same subnet as the computer and are displayed as **Accessible** in the camera list.

Selecting Cameras

You can highlight the cameras that you would like to display and manage in MxEasy. If you select a camera with the status **OK**, MxEasy automatically displays the live images from that camera in the preview window. If you are using [Ctrl]-click to select additional cameras, the image from the camera selected last is shown in the preview window.

Editing The Camera List

Use the context menu commands (right-click) to add MOBOTIX cameras to or remove them from the list. In addition, you can display further information of a camera and change the user name/password of a camera. For more information on this topic, see the MxEasy User Manual.



Do you really want to manage the following MOBOTIX IP camera(s)?

- mx10-3-124-254
- doku-m12d-secdn
- doku-d12d-180

Please note that the current configuration of the camera(s) may be changed! You can restore the current configuration at any time when removing the camera(s) from MxEasy!

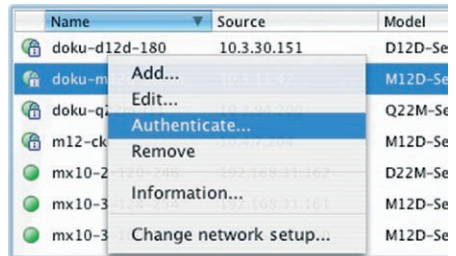
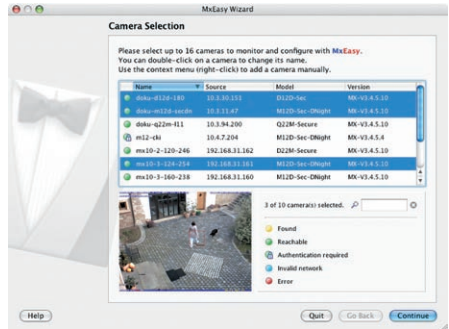

Using The Selected Cameras

Clicking **OK** prompts MxEasy to use the selected cameras and to generate a screen with the live images of the four cameras that you selected first.

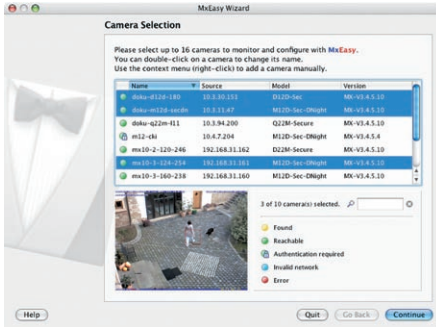

The panel at the bottom right-hand corner always displays the most recent event image of whatever camera is visible in the large panel. Double-click a small camera panel to move this camera's live image to the large panel. Click the **Add cameras** button at any time to add MOBOTIX cameras to MxEasy (max. 16 cameras in total).



"Add cameras" button (marked red)

Last event image (marked red)

3.2.5 Starting The Camera With An Automatic IP Address (DHCP)

If your network has a DHCP server, you can start the MOBOTIX camera with DHCP support. In this case, the DHCP server automatically assigns and announces an IP address (also for Q24M Basic). Note that this announcement function can be deactivated (**Admin Menu > Loudspeaker and Microphone**).

Carry out the following steps to start the camera with a DHCP address:

1. If the camera is running, disconnect the camera's power supply.
2. Reconnect the power supply of the camera.
3. Wait until both LEDs light up simultaneously for the first time. Press the camera's **"R" key** within four seconds. Use a **paper clip** for this purpose but **avoid using sharp or pointed objects!**



4. After about two more seconds, the camera plays a sound ("Boing, Boing").
5. After about another 15 seconds, the camera will automatically announce its network data, i.e. IP address, network mask and MAC address. You can now access the camera using the IP address it just announced.

Push the "R" button to announce the network data again

In case of an error, the camera uses its last IP address

Notes

Starting the camera with an automatic IP address (DHCP) is only **temporary**. The network configuration of the camera can be set to DHCP permanently under **Admin Menu > Ethernet Interface**.

Caution

When starting the camera with DHCP support, make sure that the network has a functioning DHCP server. If this is not the case, the camera cannot obtain a valid IP address and will use its last IP address.

You should also make sure that the cameras always obtain the same IP addresses by assigning the MAC addresses of the cameras to the desired IP addresses.

3.2.6 Starting The Camera With The Factory IP Address

Under certain circumstances, you may have to reset the camera to its factory IP address. This could be the case, for example, if the IP address has been lost or the camera does not respond to the last known IP address.

Passwords and camera settings will not be changed!

1. If the camera is running, disconnect the camera's power supply.
2. Reconnect the power supply of the camera.
3. Wait until both LEDs light up simultaneously for the first time.
4. Press the camera's **"L" key** within four seconds. Use a **paper clip** for this purpose but **avoid using sharp or pointed objects!**



5. After about two more seconds, the camera plays a sound ("Boing"). The camera is now accessible using its factory IP address (see label on the camera housing).

Notes

If you use the camera's **"L" key** to load the factory network configuration, this configuration is not automatically saved in the camera's flash memory. When the camera is next rebooted without using **"L" key**, the last stored network configuration will be used. To permanently store the new network configuration in the camera's flash memory, open **Admin Menu > Store**.

Make sure you store the factory network configuration in the permanent flash memory!

Caution

As opposed to resetting the camera using **Admin Menu > Reset configuration to factory defaults** the user information will not be reset if the camera is booted using the factory IP address.

Users and passwords will **not** be changed!

3.3 Virtual PTZ And Special Q24M Configuration

3.3.1 Preparing The Virtual PTZ Function

The virtual PTZ function allows you to use a mouse or joystick to continuously zoom in on images from the selected video source and "virtually" move the enlarged image section within the entire image sensor area.



Greater ease of use through a joystick

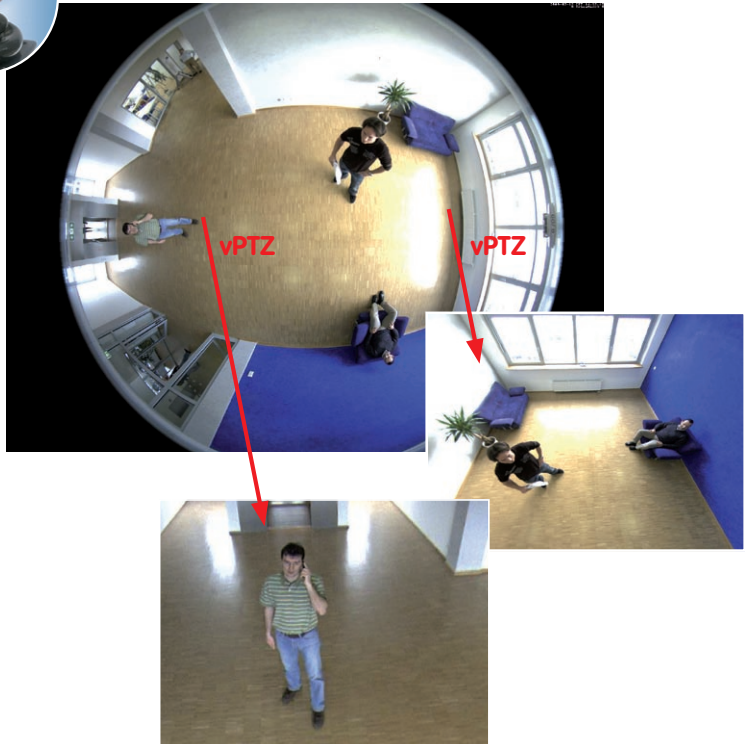

Operation Using The Mouse And Scroll Wheel

The vPTZ function of the Q24M can be controlled in the browser using the mouse. By clicking any position on the image displayed on the monitor, this position becomes the new image center. The image moves accordingly and the image distortion is automatically corrected. The **scroll wheel** can be used to control the zoom function. This functionality is disabled in the default settings of the camera, and must therefore first be activated. To do so, go to **Setup Menu > vPTZ Settings** and uncheck the **Lock Mouse Wheel Zoom** item. Then save the settings by clicking **Set** and **Close**. You can now use the scroll wheel to zoom + (roll upwards) or zoom - (roll downwards).

Virtual PTZ And Special Q24M Configuration

Operation Using USB Joystick

A standard USB joystick can drastically facilitate vPTZ operation for the user – in the browser, in MxEasy and in the MxControlCenter (however, MxCC is also equipped with a virtual joystick that can be operated using the mouse). Please first install the joystick on the PC according to the manufacturer's instructions.

In order to use a USB joystick in the browser, make sure that you have a PC with a Windows operating system and the latest version of Internet Explorer and that the **"ActiveX" mode in the camera software (browser) is activated:**

- Switch to **"Browser"** in the Quick Control.
- Under **"Browser"**, select the **"ActiveX"** option. The USB joystick can then be used until the browser is closed.
- To store the setting permanently, ActiveX must be activated in the **Admin Menu**. To do so, use **"Language and Start Page"** in the Admin Menu.
- Under the page options, select the **"ActiveX"** operating mode.
- Store the settings permanently by clicking **"Set"** and **"Close"** in the Admin Menu.
- The joystick can now be used.

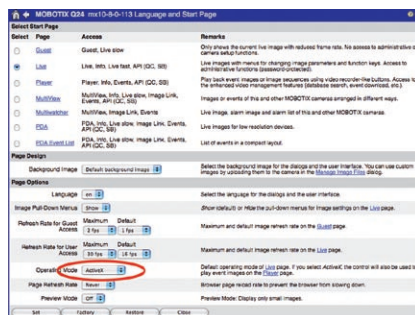
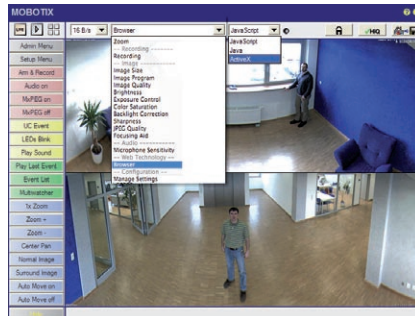

Notes

You will find more information and details on vPTZ in the **Camera Software Manual Part 2**, section 4.3.6 (Virtual PTZ), the **MxEasy** manual, section 2.4.1 (Activating the PTZ Features), the **MxControlCenter** manual, section 2.4.6 (Using the vPTZ Features) and section 3.1.4 ("PTZ Controls" in the sidebar panel).

The latest versions of all manuals are available, as always, at www.mobotix.com, Support > Manuals.

3.3.2 Special Q24M Configuration In The Browser

Thanks to its hemispherical lens, the MOBOTIX Q24M provides certain special configuration options for the image settings. Depending on where the camera is mounted (ceiling or wall) and on the live image display preferred by the user, certain important basic settings and, if necessary, their adjustment must be configured when a Q24M is first installed.

A corresponding adjustment of the image setting is strongly recommended if the on-wall set is mounted with an inclination of 10 degrees (available as a Q24M accessory).

To configure the Q24M basic settings in the browser (without installing the software), carry out the steps described on the following pages:

1. **Log the camera on and boot it** as described in section 3.2.
2. **Select mounting position wall/ceiling:** Click **"Installation"** in the Quick Control panel and then select **"Wall"** or **"Ceiling"** according to the position of the camera. **"Ceiling"** always means that the camera points **from top to bottom**, so this is also the case for a lowered mounting on an extension attached to the wall (see section 1.1).

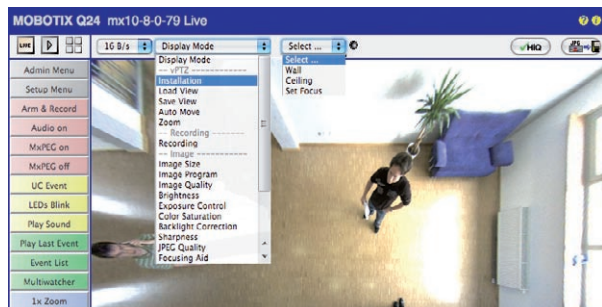

3. **Important:** After the camera has been installed, the **"Installation"** option can only be selected if the **"Display Mode"** was set to **"Normal"** beforehand.
4. The result is a **corrected default view**. This serves as the basis for carrying out all vPTZ commands.
5. Then switch to the Quick Control **"Display Mode"**.
6. Set the mode that you want to be the standard view. For demonstration purposes, the descriptions below describe the typical display mode for the wall mount and the ceiling mount, **"Panorama"** and **"Surround"** respectively. Every other display mode can be operated in the same way (see section 3.3.3, Overview of the Available Camera Views).

Wall Mount: Setting And Correcting The Standard View "Panorama"



High-resolution 180° Panorama

High-resolution 180° Panorama

Camera live image with panorama correction

1. In the Quick Control "**Display Mode**", select the option "**Panorama**". Examine the image which is now displayed. If the section meets your expectations, no further adjustment is necessary, and panorama configuration is complete. To change the image section to meet your specific expectations, continue with step 2.

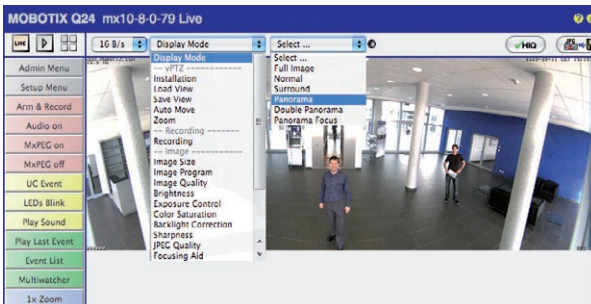

Camera live image without panorama correction with QuickControls visible

Note

The currently visible image section may differ from the desired image section due to e.g. the installation position or any accessories in use. However, it is not necessary to physically move the camera, as in this case the browser alone can be used to adjust the visible panorama image by zooming, panning and tilting. Tilted vertical lines may also be optically straightened to the image edges using the panorama correction function. These tilted lines are primarily caused if the camera itself is tilted (camera installed with 10° On-Wall Set) or if the image tilt has been modified.



Lock open

Click the icon

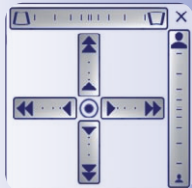

Camera live image with panorama correction with OnScreen Control visible

- Click the **lock icon**. Clicking the lock once opens it (lock clasp is raised). The lock prevents execution of later vPTZ actions, and thereby also unintentionally modifying the view you configure. This holds for all overview display modes, i.e. also for panorama focus, double panorama and surround.

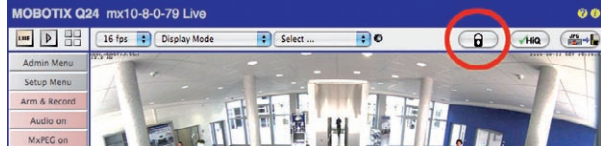

- A new **icon for processing the panorama image** appears in the top left corner of the camera image. Enlarge the image by clicking the icon once (On Screen Control appears).

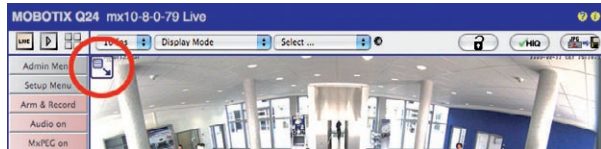

- Using the **On Screen Control** visible in the camera live image, you can now change the displayed live camera image as desired (panning, tilting, zooming and correcting the panorama; see page on the right). When doing so, the vPTZ function using the mouse or joystick is deactivated.

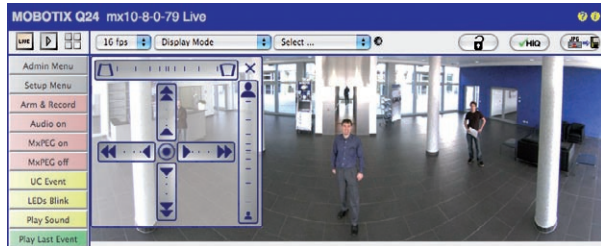

- When you have modified the desired image setting, close the control panel (x in the top right hand corner).
- Click the lock icon again** to close it (lock clasp is down). The panorama image setting is then locked until the camera is next restarted.

Caution

To permanently save the standard image setting defined for the Q24M, select the **"Store Complete Configuration"** option under the **"Manage Settings"** in **Quick Control**. The settings will then remain in effect, even after rebooting.

Use the Q24M On Screen Control:

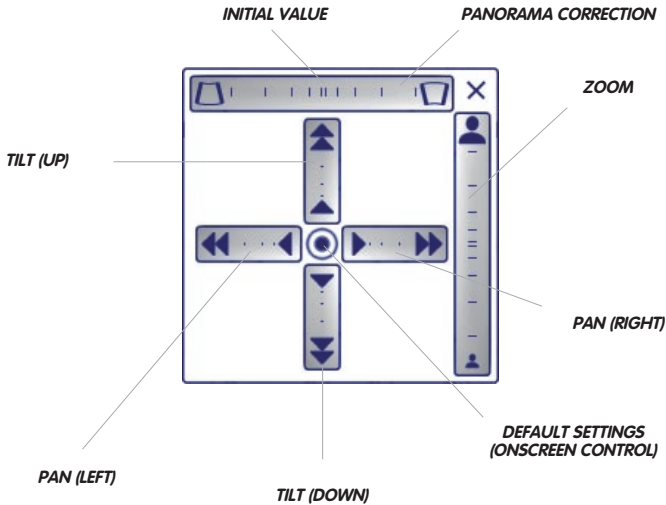

You can set the On Screen Control by clicking the individual areas (panning, tilting, zooming, correcting the panorama) in two different directions with the mouse.

Each area is represented by a horizontal or vertical bar with a central point. **The further away from this central point that you move the mouse, the greater the change triggered.** Clicking the central point of the cross leads directly to the default setting of the On Screen Control.

During panorama correction, clicking between the two trapezoid symbols straightens the left or right tilting lines, which are best visible at the edges of the image section.

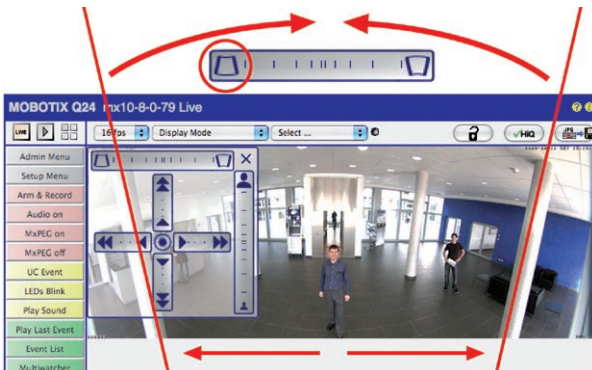

Bring columns together at the top (necessary to correct the example on the left)



Bring columns together at the bottom

Ceiling Mounted: Set North (User-Defined North Direction)

If the camera has been mounted to a ceiling, the Q24M should be set to "North". This is not the "real" direction of North but rather the **main line of sight or the focus** of camera. It serves a reference for the North direction in the display mode "**Surround**" and "**Double Panorama**" (You have already selected the "**Ceiling**" option in the "**Installation Type**" QuickControl).

1. In the Quick Control "**Display Mode**", select the option "**Normal**".

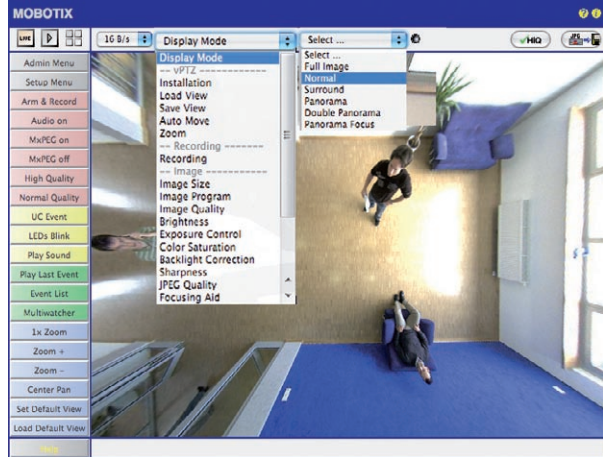

2. **Rotate the live image** in the desired direction using the mouse or a joystick connected to the computer.

For vPTZ use and the configuration of a USB joystick, see section 3.3.1

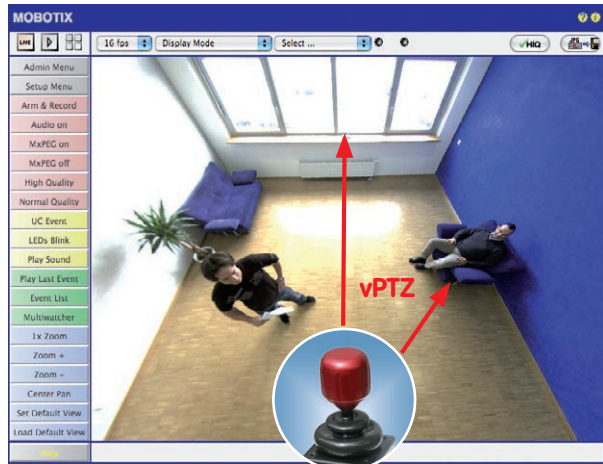

- In the Quick Control "Installation", select the option "Set North".

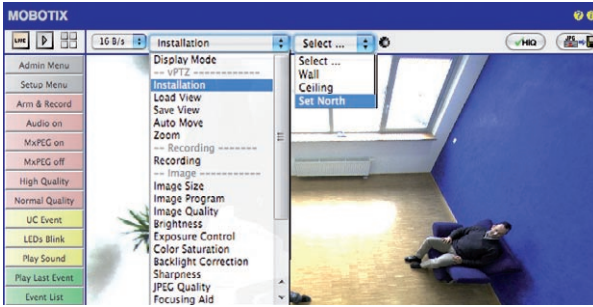

- Store the desired North direction permanently by first activating the checkbox and then clicking "Yes".

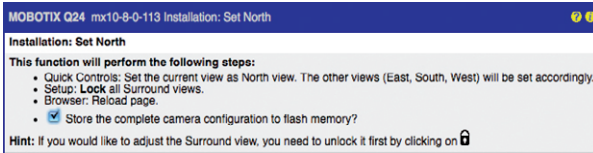

- You have now set the North direction for the display mode "Surround" and "Double Panorama". In the next step you can set these views as the standard view for the camera live image. In the Quick Control "Display Mode", select the option "Surround"



or "Double Panorama". You can fine-tune the views using the vPTZ via mouse or joystick and, as described above, by unlocking and locking the standard view using the lock icon (open lock - correct display - close lock again).

Caution: No OnScreen Control is available in "Double Panorama" mode

3.3.3 Overview Of The Available Camera Views

Full image (Mounted To A Ceiling Or Wall)

The entire fisheye full image of the image sensor (without distortion correction) is displayed.

The full image with a resolution of up to 3.1 megapixels is created by a special L11 lens (field of vision horizontal/vertical: 180°/160°)



Normal (Mounted To A Ceiling Or Wall)

A corrected image section is displayed that can be panned, tilted or zoomed. This is the factory default image setting for the Q24M.

The live image calculation and distortion correction is done directly in the camera and does not burden the PC or the network.



Virtual PTZ And Special Q24M Configuration

Surround (Mounted To Ceiling)

The images of four virtual cameras in each of the four directions are displayed in the same view. To do this, the camera's "North" direction (image top left) must be set (see section 3.3.2). All four views can be changed independently of each other using vPTZ commands.



Original Q24M image:
Each of the 4 views can
be individually modified

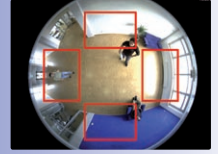

Original full image

Panorama (Mounted To Wall)

The corrected image of an entire room (corrected 180° panorama) from the left to the right wall is shown. This view is available for a wall-mounted MOBOTIX Q24M. The aspect ratio of the view is 8:3 (width to height).



Original full image

Double Panorama (Mounted To Ceiling)

A 180° panorama view for the Northern half of the image together with a panorama view of the Southern half in the image with an aspect ratio of 4:3 (width to height) is shown. This view is available for a ceiling-mounted Q24M. Both partial views can be changed independently of each other using vPTZ commands. North is defined in the "Normal" display mode using the Quick Control "Installation" and then "Set North" (see section 3.3.2). This allows you to hide an area of less interest in a monitored room by adjusting the North and South views.

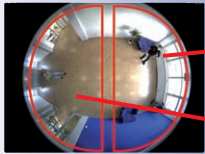

Original full image



Panorama Focus (Mounted To Wall)

This view combines the panorama view with two virtual 180° views of the entire room and provides a combination of the panorama view (8:3) and two smaller individual images (with an aspect ratio of 4:3 each) in one large image. This view is available for a ceiling-mounted Q24M.



Original full image



3.4 MicroSD Card Recording

3.4.1 Introduction

Flash-based storage devices (MicroSD cards, CF cards, USB sticks and solid-state disks) do not contain any moving parts as compared to the commonly used hard disks. Flash-based devices are compact, extremely resistant to humidity and shock, use very little energy, do not lose data during power failures and are becoming less expensive. They are thus ideally suited for use with the MOBOTIX cameras.



Number Of Write/Delete Cycles Per Flash Storage Cell

The number of write/delete cycles of every storage cell of a Flash device is limited (e.g. 10,000, 100,000 or more, depending on the quality). The controller of the Flash device automatically detects individual Flash cells that are no longer functioning. The contents of the faulty cell will then be rebuilt using a checksum and will be moved to a properly working spare cell. The faulty storage cell will be marked as "bad" and will not be used any more. No data is lost in this process.

In addition, MOBOTIX cameras constantly monitor activated Flash storage devices. MOBOTIX has developed a technology to test the wear of the Flash device by logging the number of write/delete cycles (patent pending). The Flash memory wear is automatically displayed in the status bar in the live camera image but it can also be viewed at anytime in the **Admin Menu > Camera Status** dialog.

Conservative Memory Usage Thanks To MOBOTIX MxFFS File System

MxFFS formatting of the MicroSD card means that the MOBOTIX camera software will use the Flash device as evenly as possible, thus allowing for the maximum possible number of write/delete cycles. This also means that all storage cells of the Flash device will be written and deleted with the same frequency, if possible. The MOBOTIX technology increases the life of the Flash device considerably and also improves the security and the reliability of the storage process.

Storage Requirements And Life Expectancy Of MicroSD Cards

The life expectancy of a MicroSD card increases proportionally to the storage capacity, since the camera software will execute fewer write/delete cycles on each storage cell. The first deletion begins once the card has been filled to capacity (first full cycle). The theoretical life expectancy of a 16 GB MicroSD card is between 10 and 35 years, depending on the degree of use.

32 GB MicroSD Card: Storage Requirements and Life Expectancy						
	6 fps CIF		6 fps VGA		1 fps Mega	1 fps QXGA
	M-JPEG	M-JPEG	MxPEG	M-JPEG	M-JPEG	
File size single image	15 kB	45 kB	-	120 kB	240 kB	
Storage req. per second	90 kB	270 kB	75 kB	120 kB	240 kB	
Storage req. per 24 hrs	7.8 GB	23.5 GB	6.5 GB	10.4 GB	20.8 GB	
Time for one full cycle	4 days	1.3 days	4.8 days	3 days	1.5 days	
Est. theor. life expectancy	60 years	20 years	73 years	46 years	23 years	

4 GB MicroSD Card: Storage Requirements and Life Expectancy						
	6 fps CIF		6 fps VGA		1 fps Mega	1 fps QXGA
	M-JPEG	M-JPEG	MxPEG	M-JPEG	M-JPEG	
File size single image	15 kB	45 kB	-	120 kB	240 kB	
Storage req. per second	150 kB	270 kB	75 kB	120 kB	240 kB	
Storage req. per 24 hrs	7.8 GB	23.5 GB	6.5 GB	10.4 GB	20.8 GB	
Time for one full cycle	12 hours	4 hours	14.4 hours	9.2 hours	4.4 hours	
Est. theor. life expectancy	7.6 years	2.5 months	8.8 years	5.6 years	2.8 months	

Caution

It is recommended to use only high-grade MicroSD cards that are new.
 For security applications, it is highly recommended to exchange the MicroSD card for a new one after one year of operation.

Monitoring The Cell Wear Of Flash Storage Devices (Patent Pending)

MOBOTIX uses its own technology for this purpose and has a pending patent. You can view the Flash wear in the status bar of the live image or by opening **Admin Menu > Camera Status**. In addition, the camera can send a warning message (e.g. via e-mail) if the Flash cell wear reaches a critical value (**Admin Menu > Storage on External File Server / Flash Device**). This leaves enough time to exchange the MicroSD card before the danger of data loss becomes too high.

File Server / Flash Device	
Type	SD Flash Card
File System	MxFFS
Flash Wear	1%
Transfer Buffer Usage	0% (0: 0%, max: 0%)
Lost Event Images	0
Sequences	1 (1 files)
Newest Sequence	1970-01-01 01:00:00 #0
Oldest Sequence	1970-01-01 01:00:00 #0
Current Usage	4.0 MBytes (0.4%)
Max. Size	936 MBytes

Follow these steps to format a MicroSD card in Admin Menu > Storage on External File Server / Flash Device

The Safe Formatting option takes several hours. You can also use suitable applications on Windows, Linux/UNIX and Mac OS X computers to safely format the MicroSD card.

3.4.2 Formatting The Card

Before a MOBOTIX camera can store image and video sequences on a MicroSD card, it needs to be formatted as MxFFS (MicroSD cards delivered with MOBOTIX cameras are already MxFFS-formatted). The following steps are necessary to format a storage device (**Admin Menu > Storage on External File Server / Flash Device**):

1. Make sure that there is a MicroSD card in the card slot of the MOBOTIX camera.
2. Click the **Format** button under **SD Flash Card**.



3. Select the *Quick Format* option and confirm by clicking **OK**.

Note: In contrast to the Quick Format option, the *Safe Format* option will make sure that the data on the MicroSD card is overwritten completely so that the data cannot be recovered in any way. However, keep in mind that the Safe Format takes considerably more time.

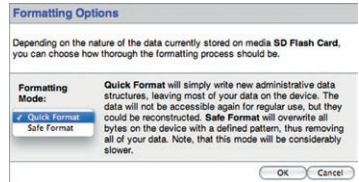

4. Enter the user name and the password of a user of the *admins* group in the dialog that opens and click **OK** to confirm. The MOBOTIX camera now starts formatting the card. It usually takes between 5 and 12 minutes to format an 8 GB MicroSD card using the *Quick Format* option and 3 to 14 hours using the *Safe Format* option.



Once the formatting has been completed, you can activate the MicroSD card for recording (see next section).

Caution

Make sure that you always wait until the formatting process has been completed before accessing the camera again. This usually takes only a few minutes when using the Quick Format option! You can only access the SD card once MxFFS formatting has completed!

The Safe Formatting option takes several hours. You can also use suitable applications on Windows, Linux/UNIX and Mac OS X computers to safely format the MicroSD card.

3.4.3 Activate Recording:

Follow these steps to activate the recording to a MicroSD card that has already been MxFFS-formatted (**Admin Menu > Storage on External File Server / Flash Device**):

1. Make sure that there is a MicroSD card in the card slot of the MOBOTIX camera.
2. Make sure that the MicroSD card has been MxFFS-formatted (see section 3.4.2, *Formatting the Card*).
3. Activate the **SD Flash Card** option.
4. Click **Set**, then **Close** to store the configuration.
5. Reboot the MOBOTIX camera (**Admin Menu > Reboot Camera**).
6. Once the camera has rebooted, make sure that the camera displays the symbols **FR REC** in its live image. If this is the case, the camera uses the SD card as recording target. If not, you can activate the recording (see below).

Activating The Recording

If the symbols **FR REC** are not visible in the camera's live image after rebooting, you need to activate the recording using one of the following methods:

- **In the web browser:** Automatic activation by clicking the **Arm & Record** softbutton. Confirm this in the **Easy Dialog** by clicking **Yes**.
- **In the web browser:** Manual activation via the Quick Control **Recording > Recording on** or in **Setup Menu > Recording**.
- **MxEasy:** You can use the MxEasy's Alarm Planner feature to activate recording based on time and date (see also section 2.5, *Setting Up Alarms and Recordings*, in the *MxEasy User Manual*).

Activating Encryption And Authentication

If security is an issue, you can opt to store only encrypted video data on the MicroSD card. If you would like to use encryption, make sure that you activate this option when formatting the card. Note that you also need to enter an Authentication password. Switching from encrypted to unencrypted storage (and back) is not possible without reformatting the card.

Follow these steps to activate the recording on an MicroSD card in **Admin Menu > Storage on External File Server / Flash Device**

This feature will be available in future software versions

3.4.4 Accessing Camera Data

The following options facilitate access to the stored image and video sequences on a MicroSD card:

- **In the web browser:** Play back the recorded event images without audio directly from the MicroSD card using the Playback view of the camera software.
- **In MxEasy:** Play back the recorded video sequences with audio by accessing the MicroSD card in the MOBOTIX camera via the camera.
- **In MxControlCenter:** Play back the recorded video sequences with audio by accessing the MicroSD card in the MOBOTIX camera via the camera or with a direct access to the MicroSD card via a card reader connected to the computer. Access the card by setting the MicroSD card's drive/volume as a "directory" in MxControlCenter.

If the MicroSD card's contents are encrypted, you need to enter the corresponding password before you can access the recorded video data. A dialog will automatically appear in MxControlCenter or MxEasy.

Caution

When using the MicroSD card from one MOBOTIX camera in another MOBOTIX camera, you need to make sure that the time on the original camera is in sync with the new camera. It is recommended to use automatic time synchronization via a time server (Admin Menu > Date and Time).

3.4.5 Deactivating The Card Memory

Follow these steps to deactivate the memory on a MicroSD card (**Admin Menu > Storage on External File Server / Flash Device**):

1. Activate the **None** option.
2. Click the **Set** button at the bottom of the dialog and then **Close**.
3. Reboot the MOBOTIX camera (**Admin Menu > Reboot Camera**).
4. Once the camera has rebooted, make sure that the symbol **FR REC** is no longer visible in the bottom right hand corner of the live image.
5. You can now safely remove the MicroSD card from the camera (see section 2.10).

Caution

A MicroSD card may only be removed from the camera after you have deactivated Recording to MicroSD Card and rebooted the camera. Failing to do so may lead to data loss!

Removing connected flash storage devices from the camera without properly deactivating them may lead to data loss and/or destroy certain areas of the storage device. Due to MxFFS formatting, this is limited to 4 MB of lost data per incident. A FAT-formatted device could lose all its data if the device was removed before being deactivated!

3.4.6 Using A MicroSD Card In A Different MOBOTIX Camera

A MicroSD card containing recorded video data from a MOBOTIX camera can be inserted into any MicroSD card-enabled MOBOTIX camera. Once MicroSD card recording has been activated (requires a reboot), the "new" MOBOTIX camera automatically synchronizes with the card and resumes recording. Note that no data is lost in this process. Make sure that you deactivate MicroSD card recording before removing the card and reboot the MOBOTIX camera!

If the MicroSD card's contents are encrypted, you need to enter the correct password in the "new" camera in the **Admin Menu > Storage on External File Server / Flash Device** dialog. Otherwise, the camera cannot access the MicroSD card.

3.4.7 Limitations On Warranty When Using Flash Storage Devices

MOBOTIX will not assume any responsibility for Flash storage devices (e.g. MicroSD cards or connected USB storage devices) delivered with or integrated into MOBOTIX cameras. The same applies to damage to Flash storage devices or damage resulting from the use of devices that the customer did not buy from MOBOTIX.

3.5 Q24M Storage Options - Full Image Storage

It is possible to store a **full image (fisheye)**, regardless of the live image stream that is being displayed. This ensures that the recording always contains the full image, even though the operator may have used the vPTZ features to zoom into the image in order to examine a specific detail.



This applies particularly to Q24M models, which rely strongly on the digital **vPTZ features in the live image**. This means that you can use the vPTZ features in VGA resolution to pan, tilt and zoom the live image while the camera is e.g. recording full images at 1 fps in MEGA or QXGA resolution.

When using **MxEasy** or **MxControlCenter**, the recorded full images may be corrected and prepared for the user with vPTZ functions (e.g. tilt and zoom on an image feature and correct the scene).

If **full image storage is not activated**, only the last displayed live image will be saved (save what is seen). The **main benefit** of live image storage is to ensure that the full power of the camera processor is used for live image correction and maximum image rates.

The **main advantage of full image storage** lies in the special functionality of the Q24M, in that it can always maintain availability of a maximum size (full) image for later investigation, despite vPTZ actions carried out on the live image. The mechanical limitations of motor-driven PTZ cameras mean that they simply **cannot** provide this unique advantage to the user!

Activate/Deactivate Full Image Storage In The Browser

To configure this feature, open the **Setup Menu > Event Control > Recording** dialog and activate or deactivate the "Full Image Recording" option.

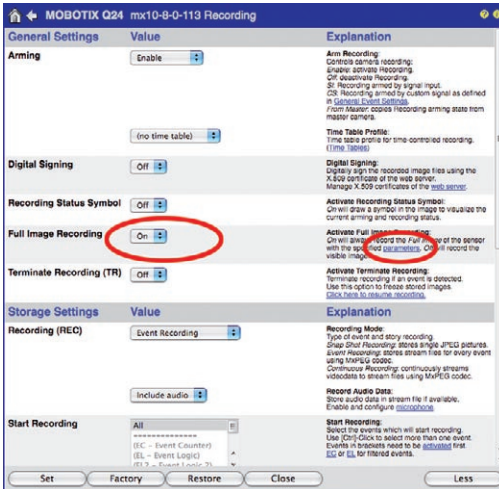

Notes

Post-event search in the full image: If you are using Full Image Recording on Q24M cameras, you should use at least MEGA resolution when storing. This will facilitate later searches in **MxControlCenter** or **MxEasy**. The advanced distortion correction features require this resolution to deliver satisfactory image quality.

Full Image Recording On: Due to its increased computing power, full image recording reduces the data rate of the live image stream, which may drop by about 10 to 30 percent. It is therefore recommended to reduce the image rate for storage as much as possible, so as to affect the live image stream as little as possible.

Full Image Recording Off: The event that triggered a video motion (VideoMotion VM) window may not be in the recorded sequences as the window was not displayed at the time.

3.6 Further Configuration In The Browser

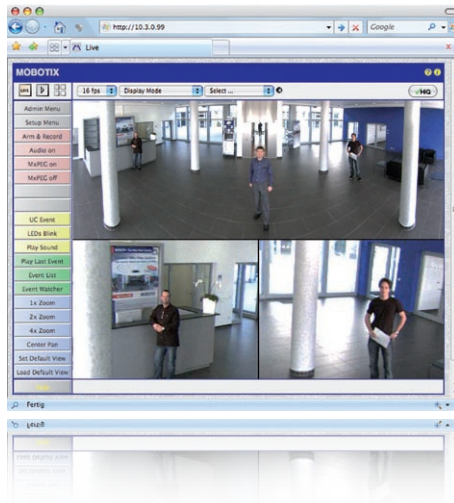

3.6.1 Overview

A MOBOTIX camera can be completely configured using a JavaScript-enabled browser on all common operating systems (such as Windows, Linux, Macintosh, etc.). The camera provides a HTML-based user interface for this purpose. The camera executes the changes you make to the camera configuration via HTTP commands using programs and scripts of the embedded software. The settings are stored in the camera's flash memory.

This section contains an overview of the general browser settings of the MOBOTIX camera, as well as further configuration options. Q24M-specific configuration steps can be found in section 3.3. The Software Camera Manual Part 2 contains more detailed descriptions of the software features.

3.6.2 General Browser Settings

- **Run the Quick Installation:** After booting the MOBOTIX camera for the first time, accessing the administration menu (**Admin Menu** button) will automatically start the Quick Installation. The Quick Installation assistant helps you in setting the most important parameters of the camera. For security reasons, you should set your own administrator password and disable public access to the camera.

=> (*Software Camera Manual Part 2, Section 5.2*)

- **Disable public access:** Guest users are only allowed to access the Guest screen of the camera without entering a password. If this is not desired, you should deactivate public access (**Quick Installation** or **Admin Menu > Users and Passwords**).
=> (*Software Camera Manual Part 2, Section 5.4.1*)
- **Add users and assign access rights:** Similar to a computer operating system, you can add users and user groups and assign the desired rights (**Admin Menu > Users and Passwords, Admin Menu > Group Access Control Lists (ACL)**). This allows you to assign or deny individual access rights to specific camera functions.
=> (*Software Camera Manual Part 2, Section 5.4.1*)
- **Deactivate the automatic reboot:** In its factory state, every MOBOTIX camera will automatically reboot every morning at 3:36 am. All images in the cameras storage buffer will be deleted during this reboot. Images stored on external file servers, internal Flash storage or SD cards will NOT be affected by this reboot. Make sure that you deactivate the automatic reboot if this is not desired (**Admin Menu > Time Tasks**).
=> (*Software Camera Manual Part 2, Section 7.9.2*)
- **Optimize the image settings:** The factory image settings of MOBOTIX cameras deliver excellent images for most application scenarios and should not be changed. If you do wish to make changes, your changes should be minor and gradual. You should, however, set an image program according to the application scenario of the camera. Image programs provide a quick and simple method for adjusting the camera to the application scenario as they perform several configuration steps at once (**Image Programs Quick Control**).
=> (*Software Camera Manual Part 2, Section 5.5.2*)
- **Set the resolution of the live image:** By factory default, all MOBOTIX cameras are delivered with an image resolution of 640x480 pixels. You can select the desired resolution using the **Resolution Quick Control**.
=> (*Software Camera Manual Part 2, Section 4.3.3*)
- **Adjust the exposure:** The automatic exposure control of the MOBOTIX camera uses individually configurable windows to determine the best image exposure. Open the **Exposure Control Quick Control** and select a predefined set of exposure windows. If required, you can also define custom exposure windows (**Setup Menu > Exposure Settings**).
=> (*Software Camera Manual Part 2, Section 5.7*)

- **Activate event control and recording:** By factory default, the MOBOTIX camera's event control is disabled. Click the **Arm & Record** button to activate event control. This will activate video motion detection and recording. Cameras with integrated Flash memory (MOBOTIX R models and models with SD card) will use the Flash memory by default to store the image and video data (recording target). If desired you can set additional events and adjust the settings of the recording and storage parameters (**Setup Menu > Event Settings, Setup Menu > Recording** and **Admin Menu > Recording to External File Server / Flash Device**).

=> (*Software Camera Manual Part 2, Chapter 7 and Chapter 8*)

- **Set up actions/messaging:** Upon detecting an event, the MOBOTIX camera can trigger alarms. These alarms can be adjusted to your needs and you can assign them to one or more events: playing back a sound alarm on the camera speaker, showing the visual alarm in the camera live image, sending an e-mail or network message with the alarm image, placing a phone call, uploading an alarm image to an FTP server, switching a signal output line of the camera (e.g. for switching on the lights/opening a door). To change the corresponding settings, refer to the following dialogs: **Setup Menu > Actions, Setup Menu > Messaging** and **Messaging 2** and **Setup Menu > Enhanced Signal Out Options**.

=> (*Software Camera Manual Part 2, Chapter 7*)

3.6.3 Additional Configuration Options

- **Administering the camera:** You can modify the camera configuration in the Administration menu or the Setup menu.
- **Admin Menu:** This menu contains the basic configuration dialogs of the camera (e.g. passwords, interfaces, software update).
- **Setup Menu:** This menu contains the dialogs for configuring the image, event and recording parameters. Some of these settings can be changed using the corresponding Quick Controls in the live screen.
- **Resetting changes:** If you would like to reset some larger changes in one dialog window without resetting the complete configuration, you can use the **Default** button at the bottom of the dialog to reset only this dialog's settings to the factory defaults. If you would like to reset all image settings, you can do so using the **Manage Settings > Restore Image Settings** of the Quick Control in the live image of the camera.
- **Storing changes permanently:** Once you have finished configuring the camera, you should always store the settings in the camera's permanent memory. You can do so in each dialog (clicking the **Set** button at the bottom of each dialog will temporarily implement the change; when you click **Close**, you will be asked to store the complete configuration in the camera's permanent memory) or in the admin menu (**Admin Menu > Store current configuration into flash memory**). The **Configuration** section of the administration menu provides more functions for storing, copying and managing camera settings. For more information on this topic, see chapter 5, *Basic Camera Configuration* in the *Camera Software Manual Part 2*.
- **Time tasks and time synchronization:** Apart from a multitude of possibilities for controlling the camera using time (time tables, holiday and vacation, scheduled tasks, etc.), the camera can also synchronize its internal clock. This allows you to manually synchronize the camera with a computer or automatically using a time server or another MOBOTIX camera. The camera can use either NTP time servers or Time Protocol servers. For additional information, see section 5.4.2, *Date and Time/Time Zones and Time Servers* in the *Camera Software Manual Part 2*.
- **The "More" and "Less" buttons:** When opening some of the camera dialogs, the camera only shows the most important parameters. These dialogs have a **More** button in the bottom right corner; click it to display additional options. If all options are displayed, click the **Less** button to hide the additional options.

User Name: **admin**
password: **meinsm**

Admin Menu

Setup Menu

Make sure to permanently
store changed parameters!

Automatic time synchroniza-
tion using a time server

More: Display
advanced features

Less: Hide advanced
features

3.7 Additional Notes

3.7.1 Weatherproof Qualities

The MOBOTIX Q24M Secure has been certified weatherproof according to IP65 (absolutely dustproof and resistant to water jets) and can also be wall-mounted outdoors. The MOBOTIX Q24M-BASIC has attained a protection class of IP54 (absolutely dustproof).

3.7.2 Password For The Administration Menu

Accessing the administration area of the camera (Admin Menu button) is only possible after entering a user name and password.

- Factory default user name is **admin**
- Factory default password is **meinsm**

The Quick Installation assistant automatically appears when the administration menu is accessed for the first time. It provides an easy method to adjust the basic camera settings to the current application scenario. For security reasons, it is highly recommended to change the default administrator password after the camera has been properly configured properly.

Enter the user name and password exactly as shown above. Note that all entries are case-sensitive.

Caution

Make sure that you store information on user names and passwords in a secure place. If you lose the administrator password and cannot access the Administration menu, the password can only be reset at the factory. This service is subject to a service charge!

3.7.3 Permanently Deactivating The Microphone

Deactivating a camera's microphone may become necessary in order to protect the privacy of persons at a workplace or for other reasons. You can permanently and irreversibly deactivate the microphone in the **Admin Menu > Loudspeaker and Microphone** dialog.

Caution

This deactivation is permanent and cannot be reversed even by MOBOTIX engineers. Deactivating the microphone will also deactivate all features that use the camera's microphone.

The microphone can be irreversibly deactivated!

3.7.4 Starting The Camera With The Factory IP Address

If the camera's IP address is not known, you can start the camera with its factory IP address. Section 3.2.6, *Starting the Camera with the Factory IP Address*, describes this procedure in more detail.

3.7.5 Reset The Camera To Factory Settings

All settings of the MOBOTIX camera can be permanently reset to the factory default settings. This makes sense if, for example, you have obtained a camera without any information or you would like to reset all settings after testing the camera. In order to perform this procedure, you need to have access to the administration area of the camera (admins group). Open **Admin Menu > Reset** to reset the camera to factory defaults.

Note: All defined users will be deleted and the admin password will be reset to the factory default when you reset the camera using **Admin Menu > Reset**. If you want to maintain existing users, use the method described in section 3.2.6, *Starting the Camera with the Factory IP Address*.

3.7.6 Activate Event Control And Motion Detection

In its default configuration, the camera's event control and video motion detection features are not enabled. In order to activate event-controlled recording, open **Setup Menu > General Event Settings** and activate the Arming switch. Another method is to click the **Arm & Record** softbutton in the browser's user interface. The camera displays the video motion detection window in the live image (dotted frame in the center) and the camera automatically stores images as soon as the video motion window detects movements.

3.7.7 Deactivate Text And Logo Options

As the camera arming is deactivated in its default configuration (see preceding section), the MOBOTIX camera only displays the Text WWW.MOBOTIX.COM, the time stamp and the MOBOTIX logo at the top of the image. Once the camera arming has been activated, the text at the bottom of the live image (event, action, messaging and recording symbols) will also appear.

You can deactivate the status bar at the bottom of the live image and the text bar in the top left corner by setting **Text Display** in the **Setup Menu > Text & Display Settings** dialog to *Off*. Setting **Text Display** to *Date & Time* will only display the time stamp in the live image.

To hide the logo in the live image, open **Admin Menu > Logo Profiles** and set **Logo Display** to *Disable*.

You can reset specific parts of the configuration

If the dotted rectangle in the live image is visible, the camera is armed

Text and logos can be also deactivated or customized

3.7.8 Deactivating The Daily Automatic Camera Reboot

Per factory default, the MOBOTIX camera automatically reboots every morning at 3:36 am. The reason for this is that in some rare cases external influences (e.g. radiation in high locations) can lead to camera malfunctions. The automatic reboot will refresh the camera's memory and will ensure proper operation without requiring any interaction on the part of the user. If desired, you can deactivate the automatic reboot of the camera in the **Admin Menu > Time Tasks** dialog.

3.7.9 Browser

Current Internet browsers (Internet Explorer, Netscape, Mozilla Firefox, Safari, Konqueror, Opera, ...) with enabled JavaScript can display the camera's live images with their standard settings. Text-based browsers (e.g. lynx) cannot display the user interface and are not suitable for operating the camera.

Section 4.1.3, *Browser Settings*, in the *Camera Software Manual* contains more detailed information on possible browser problems.

3.7.10 Cleaning The Camera And Lens

If the lens becomes dirty during the installation process, clean the lens using a lint-free cotton cloth. Make sure that the lens is still in focus after cleaning and adjust its focus if required.

Cleaning The Dome:

- In order to protect the dome from being scratched and from getting dirty, only handle it using a soft cotton cloth or the protective plastic of the camera's shipping box.
- You should clean the dome at regular intervals. Always use a lint-free cotton cloth for this purpose.
- If the dirt is more persistent, add a mild alcohol-free detergent without abrasive particles.
- Make sure you instruct cleaning personnel on how to clean the camera.

Additional Notes

3.7.11 Safety Warnings

Electrical surges can be induced by other electrical appliances, improper wiring, but also from the outside (e.g. lightning strikes to phone or power lines).

MOBOTIX cameras are protected against the effects of small electrical surges by a range of measures. These measures, however, cannot prevent the camera from being damaged when stronger electrical surges occur. Particular care should be taken when installing the camera outside to ensure proper **protection against lightning**, as this also protects the building and the entire network infrastructure.

MOBOTIX recommends having MOBOTIX cameras **installed** only by specialists accustomed to installing network devices and having proper respect for the pertinent regulations regarding lightning protection and fire prevention, as well as the current technology for preventing damages from electrical surges.

Due to the high computing power of the Q24M and the corresponding environmental conditions at the installation site, the **temperature** of the sensor board may rise to a relatively high level. However, this does not affect the functionality of the camera. The lens should not be touched directly during live operation.

3.7.12 Additional Information

For more information, see the News and Functional Overview pages in the online help of the camera's browser interface. Click the  icon to open the camera's help section.

Furthermore, detailed information on the camera and its current configuration is displayed in the Camera Status dialog. Click the  icon to open the relevant page.

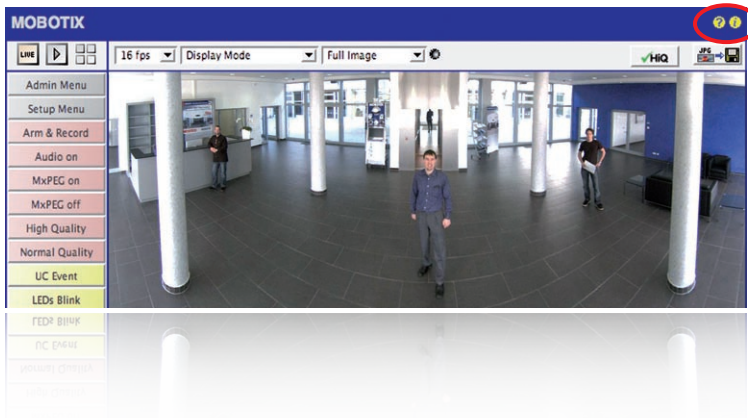

MOBOTIX GLOSSARY

ActiveX

Control element on Windows computers which may also be used in other programs (including Windows Internet Explorer) to run special tasks. The **MxPEG ActiveX** control element allows video and audio data from MOBOTIX cameras to be displayed in other applications (including Internet Explorer).

Arming

This refers to the process of activating an alarm system so that events trigger the appropriate alarms. Traditional alarm systems can be armed using a key switch or by entering a code on a keyboard. MOBOTIX cameras can be armed using a "software switch."

Auto Grid

Automatically generated grid used for displaying the live images from all cameras.

Bonjour

(French for "hello") is a technology developed by Apple based on the **Zeroconf** protocol, which is a method to automatically recognize network services on IP networks. For example, you can find a printer or a network camera on the local network without knowing the exact IP address of the device you are looking for.

CamIO

MOBOTIX signal module that the camera uses to directly operate lamps, sirens and access controls, as well as external audio components (speakers and microphones).

CCTV

Abbreviation for *Closed-Circuit Television*. A television system in which the analog video signal is transmitted to monitor within one particular environment only (for example, a building). The term CCTV is often used for video surveillance systems.

CF Card

Abbreviation for *Compact Flash Card*. An ultra-compact, digital (random-access) memory medium based on flash memory modules and well-known as an image storage medium for digital cameras.

CIF, 2CIF, 4CIF (in accordance with PAL TV standard)

Common Intermediate Format. Corresponds to 1/4 TV image with 288 rows and 352 pixels (0.1 megapixel). 2CIF (1/2 TV image) has the same small number of rows (288), but 704 pixels (0.2 megapixel). 4CIF corresponds to the image quality of a traditional TV image with 576 rows and 704 pixels (0.4 megapixel).

CMOS Sensor

Abbreviation for *Complementary Metal-Oxide Semiconductor Sensor*. Sensor for energy-efficient digitalization of image information. CMOS sensors are used as image sensors in digital cameras.

DevKit

Camera installation kit with independent image sensors based on MOBOTIX M12 or M22 cameras, intended for concealed installation in other devices.

DHCP

Abbreviation for *Dynamic Host Configuration Protocol*. Allows a server to automatically assign devices in the network with the appropriate configuration (including the IP address, DNS server and gateway), as opposed to fixed IP addresses on the individual network devices.

DNS

Abbreviation for *Domain Name Service*. Allows the domain names of servers on the Internet (e.g. www.mobotix.com) to be linked ("resolved") to their corresponding IP addresses (e.g. 212 . 89 . 150 . 84).

Dome Camera

Most often refers to cameras with a round and compact design. The lens can be freely positioned and is protected by a transparent dome-shaped plastic housing.

DSL

Abbreviation for *Digital Subscriber Line*. Denotes a fast Internet connection capable of providing bandwidth of up to 16 Mbps for a typical household.

DualDome

Dome camera with two lenses and image sensors such as the MOBOTIX D12D. These lenses can deliver wide-angle and telephoto images independently of one another.

DVR

Abbreviation for *Digital Video Recorder*.

DynDNS

Abbreviation for *Dynamic DNS* (or *DDNS*, Dynamic Domain Name Service). Similar to **DNS**, this links domain names (e.g. mydomain.com) with IP addresses, whereby the IP addresses may change at any time. This service provides a convenient method to access your MOBOTIX cameras from home or work if the camera internet connection is not through a **router** which assigns a fixed IP address, but instead over a **DSL** connection with a dynamically assigned IP address from the provider. A well-known provider of this (free) service is www.dyndns.org.

Ethernet

The most common technology for communication within a wired network. It facilitates data exchange between all devices (computers, printers, IP cameras, etc.) connected to a local area network (LAN).

Events

An event refers to a situation when something happens or changes. In terms of video surveillance, this means a change in the status of an area that is being monitored. This can be movement of a person, a change in brightness, a drop in ambient temperature, the detection of a noise via a microphone, an electrical signal at a signal input, the manual operation of a button, etc.

ExtIO

MOBOTIX signal module that the camera uses to directly operate lamps, sirens and door openers as well as external audio components (speakers and microphones).

Fixdome

Camera without moving parts in a dome-shaped housing.

Flash Memory

See **CF Card**.

fps

Abbreviation for *frames per second*. See **Frame Rate**.

Frame Rate

The frame rate specifies how many frames per second (**fps**) are generated and sent by the camera. The human eye perceives movement as a fluid video sequence when more than 12 images per second are produced.

HDTV

Abbreviation for *High Definition TV*.

HiRes

Abbreviation for *High Resolution*. Refers to high-resolution images (above 1 megapixel).

Image Compression

Image compression reduces the file size of an image. This is particularly important when transferring and saving files.

Image Processing

Digital image processing. The goal is to correct errors made during image generation (caused by overexposure, underexposure, blurring, weak contrast, image noise, etc.) in order to create a "better" image.

IP Network

Data network based on the *Internet protocol* (TCP/IP).

IP Telephone

See **VoIP**.

JPEG

Abbreviation for *Joint Photographic Experts Group*, responsible for the development of the JPEG standard method for image compression. JPEG is the most common lossy image format for photos on the Internet. Loss in image quality is barely noticeable at compression rates between 99% and 60%.

Latency

Time interval elapsed between when an image is captured by a camera and when that same image is displayed on the monitor.

Layout

Describes the layout of video sources on a screen site of the MxControlCenter. When

displaying the images from network cameras, the layout determines the positions and resolutions of the images displayed on the monitor. In addition to the actual video images, you can also incorporate graphic elements such as the location of the cameras, etc.

LED

Abbreviation for *Light Emitting Diode*. An electronic semiconductor component, built in to MOBOTIX cameras and add-on modules, which emits light when current flows through the component in the correct direction.

Linux

Free and open source operating system; serves as the operating system for all MOBOTIX cameras.

Megapixel

Images that are 1 million pixels. Larger formats of images can be displayed as a multiple of this, for example, 3 Megapixel is equal to 3 million pixels.

MonoDome

Dome camera with one lens.

Motion Detection

Action of sensing a movement within a particular area. MOBOTIX cameras use algorithmic methods to detect changes from image to image in predefined areas, while taking into account preset conditions. If a camera detects a movement, it signals an event and triggers an alarm.

Motion JPEG, or M-JPEG,

is a video compression method where each individual image is compressed separately as a JPEG image. Unlike MPEG, the quality of M-JPEG recordings is not dependent on movement within the image.

MPEG

Motion Pictures Expert Group. Standard for compressing and saving image and video data, resulting in quality loss. Originally created for playing entertainment content on PCs, MPEG concentrates on displaying still image material and compromises the quality of moving image material in order to increase the transmission speed.

MxControlCenter

MOBOTIX video management software for professional control of mid-sized and large camera networks.

MxEasy

MOBOTIX video management software for small and compact camera networks of up to 16 cameras.

MxPEG

MOBOTIX-developed protocol for compression and storage of image and video data with minimal network load and high image quality. The MxPEG **ActiveX** control component allows video and audio data from MOBOTIX cameras to be displayed in other applica-

tions (including Internet Explorer). To date, MxPEG remains the ONLY protocol specifically designed for security applications

NAS

Abbreviation for *Network Attached Storage*. A storage system connected via an Ethernet cable. All network devices (cameras) have access to this storage system.

Network

Group of computers that are connected via various cables and share access to data and devices such as printers and network cameras.

PIR

Passive Infrared Sensor for motion detection.

PoE

Power over Ethernet. A technology for supplying network-ready devices (such as network cameras) with power via the Ethernet data cable.

PTZ

Abbreviation for *Pan/Tilt/Zoom*. Refers to the movement of a video camera to the left and right, up and down, and to the camera's ability to enlarge an image.

Quad Display

Layout in which the images from four cameras are displayed in one window.

Resolution

Indicates the number of pixels used to produce an image. The more pixels an image has, the greater the detail when the image is enlarged. The resolution is expressed as either the number of pixel columns times pixel rows, or as a total number of pixels. A VGA image has 640 columns and 480 rows (640 x 480 pixels), which equals 307,200 pixels, or approximately 0.3 megapixel.

RoHS

This abbreviation stands for the *Restriction of Hazardous Substances Directive* and refers to EC Directive 2002/95/EC, which prohibits the use of certain hazardous substances when manufacturing products and components. The goal of this directive is to prevent these substances from harming the environment when the products are disposed of later.

Router

Network device that connects multiple networks with one another. The router creates the physical connection between the devices in different networks (like a hub), analyzes the relevant data packets and forwards ("routes") these packets to the correct target network.

SD Card / MicroSD card

SD Memory Card (Secure Digital Memory Card). A digital storage medium based on flash storage modules such as USB sticks.

Search

Monitoring of recordings, searching for a particular event.

Sequencer

Feature that automatically switches the camera displayed in the main window after a specific time delay.

SIP

Session Initiation Protocol. Network protocol for setting up, controlling and terminating a communication connection via a computer network. SIP is frequently used in conjunction with IP telephony.

Signal Input/Signal Output

Coupling an alarm triggering device (for example a fire alarm system or a network camera) to a control center or another type of transmitter (for example, a telephone or IP network). A typical signal input/output scenario in video surveillance progresses as follows: an event triggers an alarm that then displays, for example the video image from the network camera that triggered the alarm on the monitor at a control center.

Snapshot

Photograph of a situation created spontaneously and directly with a mouse click or other such event directed by the user.

Switch

Hardware used to connect multiple network devices (computers, cameras, printers, etc.) within a network. A *PoE switch* can also supply the cameras with power over an Ethernet cable.

UPS

Uninterruptible Power Supply. Refers to devices that continue to supply power in the event of a sudden power failure. These devices usually operate using a battery. UPS is installed on the power lines of devices and systems in order to protect them in the event of a power failure.

VoIP

Voice over Internet Protocol. Telephony using computer networks.

Wizard

Refers to a software component that helps the user install or set up a particular program and that guides the user through the configuration process by means of simple questions.

WLAN

Wireless Local Area Network. Used to provide Internet connections without the need for cables.

DECLARATION OF CONFORMITY

Konformitätserklärung
Declaration of Conformity
Déclaration de conformité

Hersteller: MOBOTIX AG
Manufacturer:
Fabricant :

Produkt: Netzwerk-Kamera
Product: Network camera
Produit : Caméra de réseau

Typ: Q24M
Type:
Type :

Bei bestimmungsgemäßer Verwendung erfüllt das bezeichnete Produkt die Bestimmungen der im Folgenden aufgeführten Richtlinien:
 The product identified above complies with the essential requirements of the relevant standard, when used for its intended purpose:
 Le produit désigné ci-dessus est conforme aux exigences fondamentales des normes s'y rapportant :

Niederspannungsrichtlinie 2006/95/EG
Low-voltage directive
Directive basse-tension

Angewendete harmonisierte Normen: EN 60950:2005
Harmonised standards applied:
Normes harmonisées :

EMV-Richtlinie 2004/108/EG
EMC directive
Directive CEM

Angewendete harmonisierte Normen: EN 55022:2006
Harmonised standards applied: EN 55024:1998+A1:2001+A2:2003
Normes harmonisées : EN 61000-6-2:2005
 EN 61000-4-2
 EN 61000-4-3
 EN 61000-4-4
 EN 61000-4-5
 EN 61000-4-6
 EN 61000-4-8

Weitere angewendete Normen: EN 50121-4:2007
Other harmonised standards applied: EN 55022:2006 CFR 47, FCC Part 15B
Autres normes harmonisées : C-Tick AS/NZS 3548 CISPR 22:2005 (mod.)

Anschrift: MOBOTIX AG
Address: Kaiserstrasse
Adresse : 67722 Langmeil
 Germany

+ TK-Nr. / Phone number / N° de communication :

Fon: +49 6302 9806-100
Fax: +49 6302 9806-190
E-Mail: info@mobotix.com



Langmeil, 18.05.2009

Ort, Datum
Place & date of issue
Lieu et date

Dr. Ralf Hinkel
 Vorstand/CEO, MOBOTIX AG

Name und Unterschrift
Name and signature
Nom et signature

MOBOTIX - The HiRes Video Company



**To demonstrate our confidence in the quality of our products,
MOBOTIX cameras were used to capture all the images that
appear in this manual.**

Manufacturer

MOBOTIX AG
Kaiserstrasse
67722 Langmeil, Germany
Germany

Tel: +49 6302 9816-0
Fax: +49 6302 9816-190

<http://www.mobotix.com>
sales@mobotix.com

Executive Board

Dr. Ralf Hinkel
Registration Office: Kaiserslautern Local Court
Registration Number: HRB 3724

Tax Code: 19/650/0812/1
Tax Office: Kaiserslautern, Germany

VAT ID:
DE202203501

You can find the latest version of this document at www.mobotix.com under **Support**.



Technical specifications subject to change without notice!

© **MOBOTIX AG** • **Security-Vision-Systems** • **Made in Germany**

www.mobotix.com • sales@mobotix.com



reddot design award
honourable mention 2009

Allround Easy. Allround Secure.



High-resolution 180° Panorama

High-resolution 180° Panorama

Version 09/06/Latest PDF file:
www.mobotix.com > Support > Manuals



HiRes Video Innovations

The German company MOBOTIX AG is known as the leading pioneer in network camera technology and its decentralized concept has made high-resolution video systems cost efficient.

MOBOTIX AG • D-67722 Langmeil • Tel: +49-6302-9816-103 • Fax: +49-6302-9816-190 • sales@mobotix.com

HiRes

3 Megapixel

2048 x 1536
Software zoom

Skyline

Format free

Each image format
freely definable

30 Frames/s

VGA (640 x 480)
30 F/s Mega

Virtual PTZ

Digital pan, tilt,
zoom

Backlight

Safe using CMOS
without mechanical iris

Internal DVR

Internal via SD card,
external via Network

Win/Lin/Mac

Recording

via Network on PC
up to 1 Terabyte

Microphone & speaker

Audio

bi-directional via IP,
variable framerates

SIP-Client with video

IP Telephony

Alarm notify,
cam remote control

VideoMotion

Multiple windows
precision pixel-based

-22°F ... +140°F

Weatherproof

-30° ... +60°C, IP65,
no heating necessary

EEE 802.3af

PoE

Network power
even in winter

Robust

No moving parts
fiber glass housing

McCC/Measy

Licence free

Video-Management-
Software