



\*Variant Mx-v26B supports MOBOTIX MxBus modules

## v26 Indoor Dome

Quick Install



32.850-003\_EN\_04/2018

BeyondHumanVision

MOBOTIX

### Delivered Parts



Item	Count	Part Name
1.1	1	v26 with standard dome
1.2	1	Sealing
1.3	1	Ethernet patch cable, 50 cm/19.7 in, black
1.4	1	Allen wrench 2.5 mm
1.5	1	Torx wrench TX20
1.6	1	microSD card pre-installed (SDHC montiert, SDXC supported)
1.7	1	Lens wrench, red
1.8	4	Allen screws M4x16 mm, black (for black housing) Allen screws M4x16 mm, silver-colored (for white housing)
1.9	4	Stainless steel washers Ø 5.3 mm
1.10	4	Dowels 8 mm
1.11	4	Stainless steel wood screws with Torx head 4.5x60 mm
1.12	1	Reflection protection

### Delivered Parts Vandalism Set/Vandalism Set for On-Wall Set with Audio

Except for the vandalism ring, the delivery of both sets is identical (items 2.1 and 2.1 a).

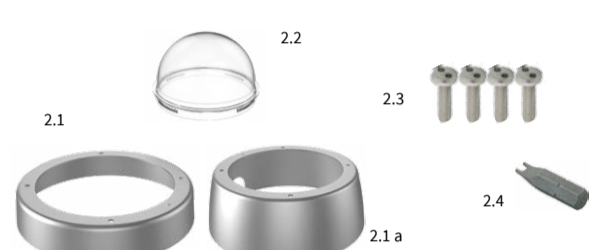

Item	Count	Part Name
2.1	1	Vandalism ring
2.1a	1	Vandalism ring (Vandalism set for On-Wall set with audio)
2.2	1	Vandalism dome, reinforced
2.3	4	Security screws
2.4	1	Screwdriver bit for security screws

### Connecting the v26



You can find detailed information on the **installation and connections** of the v26 in the Q25-Kamerahandbuch (PDF, available on [www.mobotix.com](http://www.mobotix.com) > Support > Download Center > Documentation > Manuals).

Regarding the **initial operation** of the v26, please see the D25 Camera Manual in Chapter 3, «Initial Operation».

Use a suitable device for operating the camera key (e.g., a screw driver).

### Installing the Lens

#### 1. Remove the dome

Unscrew the dome by turning it **counter-clockwise**.



#### 2. Install the lens

Using the red lens wrench, screw the lens into the lens mount.



After initial operation of the camera, remember to adjust the focus of the lens (see «Initial Operation» on page 2).

### Inserting /Exchanging the SD Card

All camera models can use the integrated microSD card (SDXC) to record video data. In order to exchange the microSD card, please proceed as outlined in the following instruction. For information on reliable SD cards, please see the MOBOTIX website [www.mobotix.com](http://www.mobotix.com) > Support > Download Center > Documentation > White Lists in the document microSD Card Whitelist for MOBOTIX Cameras.

When replacing the SD card, make sure that recording has been deactivated in the browser (**Admin Menu > Storage > Storage on External File Server / Flash Device**; activate recording again in the same dialog). To get to the back of the main board, you may have to loosen the screws at the left and right side of the main board support, and tilt the main board support slightly forward (see «Installing the v26», Step 7).

#### 1. Remove the SD card

If a microSD card has been installed, gently press with your finger as indicated by the arrow until you hear a **click**. Then release the SD card. The card is protruding slightly and can be easily removed.

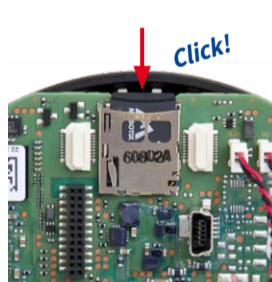

#### 2. Insert the SD card

Insert the microSD card and gently press with your finger as indicated by the arrow until you hear another **click**. Make sure that the SD card is fully inserted.

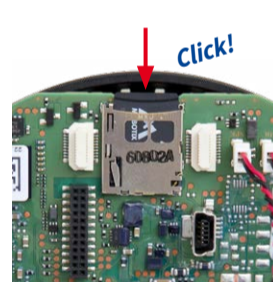

### Installing the Mx-A-IOA-IC

For the Mx-v26A/B, you can use the optionally available Mx-A-IOA-IC to attach external sensors using the signal inputs and to switch other devices via the signal outputs. When used with the the Mx-v26B, you can also attach MxBus devices (e.g., an MX-GPS-Box). To attach the Mx-A-IOA-IC Module, you need to remove the dome, You may also have to loosen the screws at the left and right side of the main board support, and tilt the main board slightly forward (see «Installing the v26» step 7).

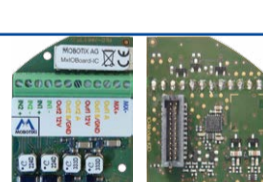

#### 1. Attach the connection cables

Attach the connection cables as shown in the terminal connector overview.

Terminal Connectors			
<b>MX-</b> <b>MX+</b> Out1 A Out1 B /GND Out1 12V Out2 A Out2 B/GND Out2 12V IN1 - IN1 + IN2 - IN2 +	MxBus connectors	MxBus functionality is only supported by the camera variant Mx-v26B.	
	Output 1 A	Relay pot.-free	Outputs
	Output 1 B/GND		
	Output 1 12 V		Output 1 12 V
	Output 2 A	Relay pot.-free	Outputs
	Output 2 B/GND		
	Output 2 12 V		Output 2 12 V
	Input 1 -	Inputs	
	Input 1 +		
	Input 2 -		
Input 2 +			

#### 2. Insert the Mx-A-IOA-IC

Hold the Mx-A-IOA-IC over the receptacle on the main board (red arrow in figure). Make sure that the green terminal connector block is pointing upward (towards the SD card, see red arrow in figure).



Use one finger to carefully press the board of the module onto the receptacle. Make sure that the Mx-A-IOA-IC is fully inserted.

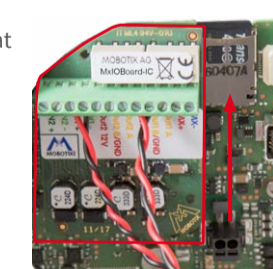

### Installing the v26

Use the drilling template on the back for this step. Mark the holes for dowels or screws if required, drill the holes for the dowels, push them in and attach the v26 with dowels and screws.

#### 1. Connect the cables

Guide the cables (network cable, USB cable, MxBus wires and signal input/output wires) through the cut-out in the sealing. When doing this, make sure that you do not damage the cables/wires. Connect the cables/wires to the v26.



#### 2. Mount the reflection protection

To avoid reflections within the interior of the white housing, you should apply the reflection protection (two pieces, item 1.12). In the black housing, the protection also covers the silver-colored screws. Place the ring around the main board support. Press the ring into the recess of the housing. Turn the housing on its back.



Now take the disc and pull it gently apart at the cut. Place the disc around the cables where the sealing and the housing meet. Push the disc down on the opening in the housing.



#### 3. Place sealing on v26

Place the sealing on the back of the v26 as shown.



#### 4. Install the v26

Press the ceiling and the wall sealings against the ceiling and align the sealings with the holes for the dowels/screws. You may have to loosen the fastening



screws (see below) and rotate the main board support to get to these screws. Insert the screws with washers and tighten them.

#### 5. Adjust viewing direction

Release the fastening screws and rotate the camera into the desired viewing direction. Tighten the screws (torque 0,4 Nm) again once you are finished.



#### 6. Start the camera and focus the lens

For the first start of the camera and for adjusting the focus of the lens, see «Initial Operation» on page 2.

#### 7. Set the tilt angle of the lens

Make sure that the lens is tilted properly. If this is not the case, loosen the screws to the right and left of the main board support and tilt the camera. Tighten the screws again once you are finished.



#### 8. Install the dome

Mount the dome. If you are using the vandalism set, install the reinforced vandalism dome instead.



#### 9. Close the screw holes

If you do not use the vandalism set, you should close off the four holes using the supplied black or silver screws, depending on the color of the set.



## Installing the v26 (continued)

### 10. Install the stainless steel ring of the vandalism set

**Vandalism set:** When using the vandalism set, attach the stainless steel ring with the security screws (torque 0,4 Nm) and use the supplied screwdriver bit to firmly tighten the screws.



### Vandalism set for On-Wall set with audio:

For installing and mounting, please follow the instructions as described in **Quick Install: Audio On-Wall Set (www.mobotix.com > Support > Download Center)**. Attach the stainless steel ring with the security screws. Make sure that the cutout in the stainless steel ring tightly fits around the cable fitting of the On-Wall set. Use the supplied screwdriver bit to firmly tighten the screws (torque 0,4 Nm).



## Initial Operation

The initial operation starts with connecting the power supply (see section «Network and Power Connection, Additional Cables» in the D25 Camera Manual). The first access follows the procedure described in the same manual in the section «Initial Operation of the Camera». All other tasks require access to the camera's user interface in the browser. Enter the camera's IP address into the address bar of the browser (user "admin", password "meinsm"; password must be changed upon first login – camera software V5.1.x and higher).

### 1. Set the lens

Open the **Admin Menu > Hardware Configuration > Lens Configuration** dialog and select the installed lens. This step is required to select the proper special functions of the installed lens (e.g., for wide-angle lenses).



### 2. Adjust the lens focus

Remove the dome before proceeding.

Check the live image from the camera in the browser. Activate the focusing aid in the browser (**Focusing Aid** quick control, **Activated** value).



Carefully turn the lens using the red lens wrench in clockwise or counter-clockwise direction until the red area of the focusing aid in the camera image is as small as possible.



Once the focus is adjusted properly, deactivate the focusing aid again (**Focusing Aid** quick control, **Disabled** value).

**Note:** Due to the lens effect of the dome, the focus of the B237 tele lens is shifting slightly once the dome has been mounted. Before mounting

the dome, the tele lens should be turned about 90° in counter-clockwise direction (as seen from the lens' front). Make sure that you check the focus of the live image in your browser with the dome installed and re-adjust the lens, if required.

### 3. Configure and use the Mx-A-IOA-IC

After starting the camera with installed Mx-A-IOA-IC, the module is recognized automatically and listed in the **Camera Status** browser dialog in the **System** section.

You can immediately use the signal inputs to define **signal event profiles** in **Setup Menu > Event Overview**. Likewise, you can immediately use the signal outputs to define **signal output profiles** in **Admin Menu > Hardware Configuration > Signal Out Profiles**.

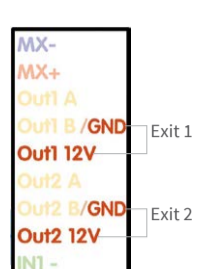

In addition, the signal inputs and outputs are automatically listed in the **Admin Menu > Assign Wires** dialog so you can use them immediately for door and light features.

If you want to use one or both signal outputs not as potential-free outputs, but as **12 V outputs**, open the **Admin Menu > Hardware Configuration > Manage Hardware Expansions** dialog. In the **/IO Board** section, click on **Connect** for each output you want to use as a self-powered 12 V output.

### 4. Save the configuration

In the live image of the browser, select the **Manage Settings** quick control and set **Store Entire Configuration** as value. The camera stores the configuration in the permanent camera memory so that the settings will be applied at the next camera reboot

## Boot Options of the v26

By default, the camera starts as DHCP client and automatically tries to get an IP address from a DHCP server. To start the camera in a mode different from the default mode, you can activate the boot menu of the camera.

### 1. Preparing the Camera

- Remove the outer shell and the dome.
- Disconnect the camera's power supply.
- Reconnect the power supply of the camera.

### 2. Activating the Boot Menu

The red LED lights up 5 to 10 seconds after establishing the power supply and will stay on for 10 seconds. Briefly press the key indicated by the red circle in the figure. The camera enters the boot menu, ready for selecting one of the boot options. To operate the camera key, use a suitable device (e.g., a screw driver).



The LED now flashes once and repeats the flash signal after pausing for one second (the number of flashes indicates the current boot option). To go to the next boot option, briefly press the key again (< 1 sec). After the last boot option, the camera returns to the first option (LED flashes once).

LED flashes	Boot Option	Meaning	Audio Confirmation*
1 x	—	This option is not used on this camera model.	—
2 x	Factory Defaults	Starts the camera with factory defaults (factory default IP address, users and passwords will not be reset).	Boing
3 x	Automatic IP Address	Starts the camera as DHCP client and tries to obtain an IP address from a DHCP server. If a DHCP server cannot be found or no IP address can be obtained, the camera starts with its factory default address.	Boing Boing
4 x	Recovery System	Starts the camera with the recovery system, e.g., in order to recover from a failed update of the camera software.	Alarm Sound

\*Only on cameras with audio option and installed speaker.

### 3. Selecting a Boot Option

Press the key longer (> 2 sec). The camera confirms the selection by flashing rapidly three times. After 20 sec, the camera will confirm the selection by playing a sound according to the table above. If nothing is selected, the camera will resume its normal boot process after a certain time.

The outer shell and the dome can be mounted again.

## Important Notes

### Safety Warnings

#### Notes on Installing:

- This product must not be used in locations exposed to the dangers of explosion.
- Make sure that you install this product as outlined in the instructions of this Quick Install document. A faulty installation can damage the camera!
- When installing this product, make sure that you are only using genuine MOBOTIX parts and MOBOTIX connection cables.
- Only install this product on suitable, solid materials that provide for a sturdy installation of the fixing elements used.

**Electrical installation:** Electrical systems and equipment may only be installed, modified and maintained by a qualified electrician or under the direction and supervision of a qualified electrician in accordance with the applicable electrical guidelines. Make sure to properly set up all electrical connections.

**Electrical surges:** MOBOTIX cameras are protected against the effects of small electrical surges by numerous measures. These measures, however, cannot prevent the camera from being damaged when stronger electrical surges occur. Special care should be taken when installing the camera outside of buildings to ensure proper protection against **lightning**, since this also protects the building and the whole network infrastructure.

**Max. power consumption of attached extension modules:** The power consumption of all attached **MxBus modules** must **not exceed 2,5 W**. When attaching modules to the MxBus connector and the USB socket, the **power consumption of all attached modules must not exceed 3 W, if the camera is powered by PoE class 3**. If **PoE class 2** is used, **the power consumption of all attached modules must not exceed 1 W!**

**Never touch the lens:** Due to the high performance of the v26, the area of the image sensor **can get quite hot**, especially when the ambient temperature is also high. This does not affect the proper functioning of the camera in any way. For this reason, the product must not be installed within the reach of persons.

**Power off before opening the camera:** Make sure the power supply to the camera is disconnected before opening the camera housing (e.g., when exchanging the SD card or when opening the body to attach wires).

**Network security:** MOBOTIX products include all of the necessary configuration options for operation in Ethernet networks in compliance with data protection laws. The operator is responsible for the data protection concept across the entire system. The basic settings required to prevent misuse can be configured in the software and are password-protected. This prevents unauthorized parties from accessing these settings.

### Legal Notes

**Legal aspects of video and sound recording:** You must comply with all data protection regulations for video and sound monitoring when using MOBOTIX products. Depending on national laws and the installation location of the v26, the recording of video and sound data may be subject to special documentation or it may be prohibited. All users of MOBOTIX products are therefore required to familiarize themselves with all applicable regulations and to comply with these laws. MOBOTIX AG is not liable for any illegal use of its products.

### Disposal

Electrical and electronic products contain many valuable materials. For this reason, we recommend that you dispose of MOBOTIX products at the end of their service life in accordance with all legal requirements and regulations (or deposit these products at a municipal collection center). MOBOTIX products must not be disposed of in household waste! If the product contains a battery, please dispose of the battery separately (the corresponding product manuals contain specific directions if the product contains a battery).

### Disclaimer

MOBOTIX AG does not assume any responsibility for damages, which are the result of improper use or failure to comply to the manuals or the applicable rules and regulations. Our **General Terms and Conditions** apply. You can download the current version of the General Terms and Conditions from our website at **www.mobotix.com** by clicking on the **COS** link at the bottom of every page.

## Technical Specifications

<b>Model Variants</b>	Mx-v26A/B*-6Dxxx (daylight image sensor, color) Mx-v26A/B*-6Nxxx (night image sensor, Black&White) Mx-v26A/B*-AU-6Dxxx (audio package, daylight image sensor, color) Mx-v26A/B*-AU-6Nxxx (audio package, night image sensor, Black&White) *Variant Mx-v26B supports MOBOTIX MxBus modules
<b>Lens Options</b>	B036 – B237 (103° to 15° horizontal angle of view)
<b>Sensitivity</b>	Color sensor (day): 0,1 lx @ 1/60s; 0,005 lx @ 1s BW sensor (night): 0,02 lx @ 1/60s; 0,001 lx @ 1s
<b>Image Sensor</b>	1/1,8" CMOS, 6MP (3072x2048), progressive scan
<b>Max. Image Size</b>	6MP (3072x2048)
<b>Image Formats</b>	Freely configurable format 4:3, 8:3, 16:9 or customized format (image cropping), e.g., 2592x1944 (5MP), 2048x1536 (QXGA), 1920x1080 (Full-HD), 1280x960 (MEGA)
<b>Max. Frame Rate</b>	MxPEG (max.): 42@HD (1280x720), 34@Full-HD, 24@QXGA, 15@5MP, 12@6MP M-JPEG (max.): 26@HD (1280x720), 13@Full-HD, 9@QXGA, 5@5MP, 4@6MP H.264 (max.): 25@Full-HD, 20@QXGA
<b>Video Codec</b>	MxPEG, M-JPEG, JPEG (max. output format 6MP) H.264 (max. output format QXGA; bandwidth limitation possible)
<b>ONVIF</b>	ONVIF-S (camera software V5.0.2.x and higher)
<b>DVR</b>	On internal microSD card (SDHC installed, SDXC supported) External on USB device External on NAS Full image recording regardless of live image zoom MxFFS Pre-alarm and post-alarm images DVR monitoring with error notification

<b>Software</b>	MxManagementCenter
<b>Image Processing</b>	MxLEO, backlight compensation, automatic white balance, image distortion correction
<b>PTZ</b>	Digital pan/tilt/zoom; max. zoom 8x (continuous)
<b>Alarm/Events</b>	Temperature sensor, shock detector (with firmware version 5.0.1 and higher), other sensors/I/Os via MxMessageSystem, notification via email, FTP, VoIP, SIP
<b>Intelligent Video Analysis</b>	MxActivitySensor, video motion analysis, MxAnalytics
<b>Audio</b>	None, expandable with, for example, On-Wall set with audio
<b>Interfaces</b>	Ethernet 100Base-T (MxRJ45), MiniUSB (MxMiniUSB), MxBus* *Only variant Mx-v26B
<b>Security</b>	User/group management, HTTPS/SSL, IP address filter, IEEE 802.1x, intrusion detection, digital image signature, MxFFS
<b>Certifications</b>	EN55032:2012; EN55022:2010; EN55024:2010; EN50121-4:2015; EN61000-6-1:2007; EN61000-6-2:2005 EN61000-6-3:2007+A1:2011; EN61000-6-4:2007 +A1:2011; AS/ NZS CISPR22:2009+A1:2010; CFR47 FCC part15B
<b>Power Supply</b>	Power over Ethernet IEEE 802.3af
<b>Power Consumptions</b>	Typ. 4 W
<b>Power Consumption of External Devices</b>	At MxBus: max. 2,5 W, at USB: max. 2,5 W, total max. 3 W The power consumption of the camera will increase accordingly!
<b>Protection Classes</b>	IP protection class: IP20 IK protection class: IK10 without accessories, IK08 with On-Wall set with audio, IK10+ with Vandalism set
<b>Ambient Temperature</b>	0 to 40 °C/32 to 104 °F
<b>Dimensions/Weight</b>	Height x diameter: 90 x 150 mm/3.54 x 5.90 in; weight: approx. 380 g
<b>Housing</b>	PBT-30GF, white and black

## Drilling Template

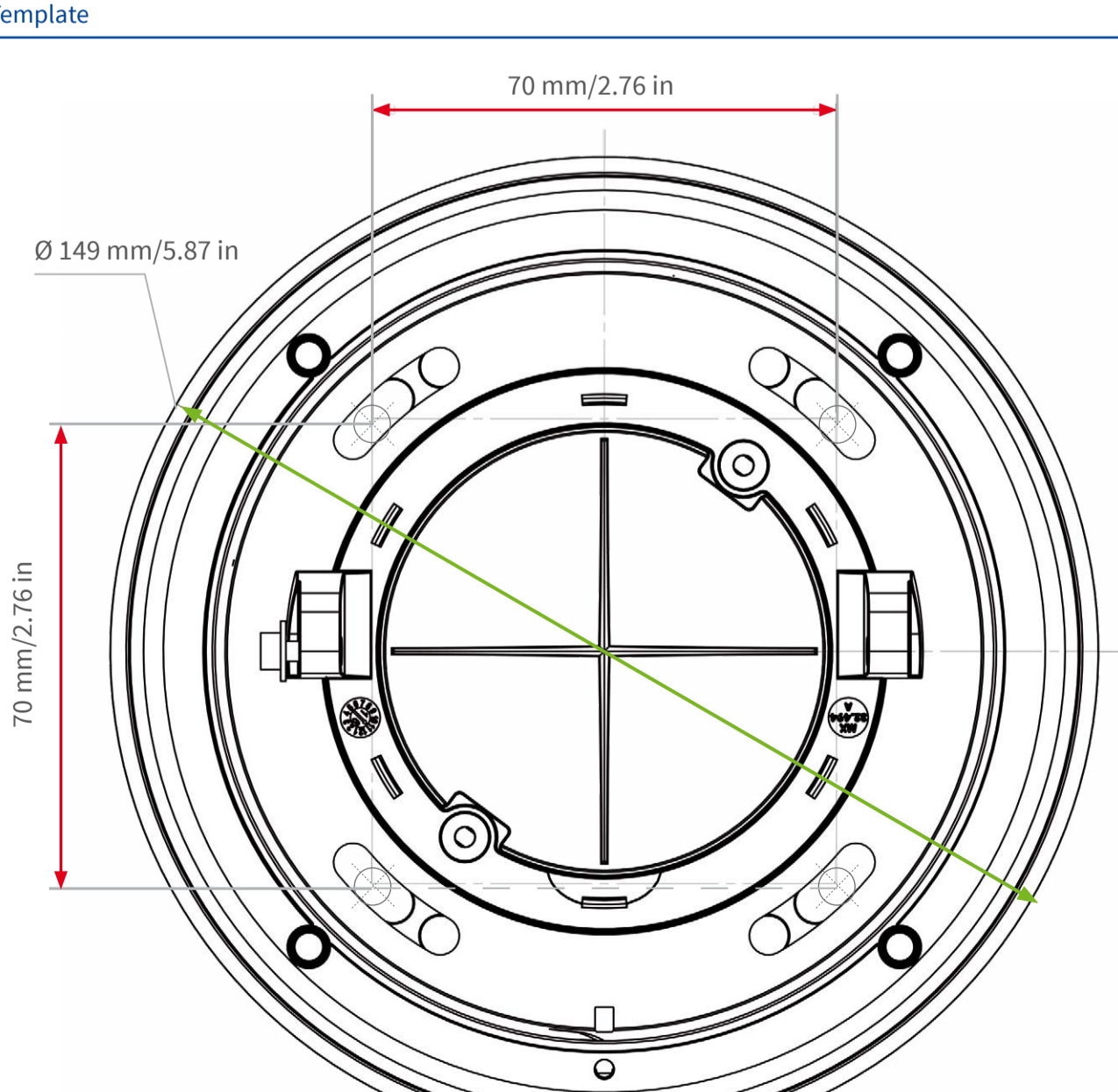

CE FC  
Further information on [www.mobotix.com](http://www.mobotix.com):

- Products > Indoor Cameras > v26 Indoor Dome
- Support > Download Center > Documentation > Certificates & Declarations of Conformity

MOBOTIX, the MX logo, MxPEG and MxActivitySensor are trademarks of MOBOTIX AG registered in the European Union, the U.S.A., and other countries • Information subject to change without notice • MOBOTIX does not assume any liability for technical or editorial errors or omissions contained herein • All rights reserved • © MOBOTIX AG 2017



**MOBOTIX**